

TRIO

The proven, universal panel formwork with only one connecting part

Product Brochure – Issue 12/2017



Content

System advantages

- 5 The proven, universal panel formwork with only one connecting part
- 6 Fast working operations
- 8 Easy and simple connections
- 10 Large-area shuttering
- 12 Safe working conditions in all situations

System overview

- 14 TRIO Panel Formwork at a glance

Standard applications

- 16 Corners, compensations and wall connections
- 18 Stopped formwork
- 19 Shuttering and striking in just a few simple steps

System supplements

- 20 Crane-independent working with TRIO Alu
- 22 TRIO Structure with any selected formlining for special surface requirements
- 24 Moving complete shaft internal formwork units with the Shaft Panel TSE and Shaft Corner TRIO

Issue 12/2017

Publisher

PERI GmbH
Formwork Scaffolding Engineering
Rudolf-Diesel-Strasse 19
89264 Weissenhorn
Germany
Telefon +49 (0)7309.950-0
Telefax +49 (0)7309.951-0
info@peri.de
www.peri.de

- System supplements**
- 26 TRIO Column Formwork – for square and rectangular columns
 - 28 PERI Push-Pull Props for aligning and supporting the wall formwork
 - 29 PERI Brace Frames – the solution for single-sided walls up to 8.75 m high

- Additional applications**
- 30 TRIO for the construction of foundations
 - 31 TRIO for use with polygonal walls

- Project examples**
- 32 TRIO in use

- Components**
- 36 TRIO Panel Formwork

Important information

All current safety regulations and guidelines applicable in those countries where our products are used must be observed.

The photos shown in this brochure feature construction sites in progress. For this reason, safety and anchor details in particular cannot always be considered as conclusive or final. These are subject to the risk assessment carried out by the contractor.

In addition, computer graphics are used which are to be understood as system representations. For ensuring a better understanding, these and the detailed illustrations shown have been partially re-

duced to show certain aspects. The safety installations which have possibly not been shown in these detailed descriptions must nevertheless still be available. The systems or items shown might not be available in every country.

Safety instructions and load specifications are to be strictly observed at all times. Separate structural calculations are required for any deviations from the standard design data.

The information contained herein is subject to technical changes in the interests of progress. Errors and typographical mistakes reserved.



TRIO Panel Formwork

The proven, universal panel formwork with only one connecting part

The focus of the universal TRIO Wall Formwork is on ensuring simple shuttering procedures and reduced shuttering times. Standard panels have only 6 different widths which allows easy handling and efficient logistics. With the BFD Coupler for all connections as well as many other practical system solutions, TRIO has successfully proven itself in countless projects around the world.

TRIO is very versatile and efficient in its use - from residential construction and multi-storey structures through to applications in infrastructure projects. This ensures a high degree of utilisation and thus the cost-effectiveness of the system. Variants of the panel formwork, e.g. the aluminum version or for special surfaces, expands the range of applications. The closed panel profiles of the TRIO provide high torsional stability. The excellent product quality guarantees a long service life. For all applications, TRIO fulfils the highest requirements regarding the evenness.

In addition, TRIO can be combined with the MAXIMO Panel Formwork System. Accessories, such as the BFD Coupler or Articulated Corners, can be used on both systems.



The standard TRIO panels have been tested according to GSV guidelines.

Fast working operations

with only a minimum of panel widths as well as panels that can be used both horizontally and vertically

Easy and simple connections

with the BRD Alignment Coupler as the only component for all panel connections

Large-area shuttering

with standard panels up to 3.30 m x 2.40 m - providing a high level of surface evenness and only 2 tie positions

Fast working operations

Simple handling and logistics due to a minimum of panel widths









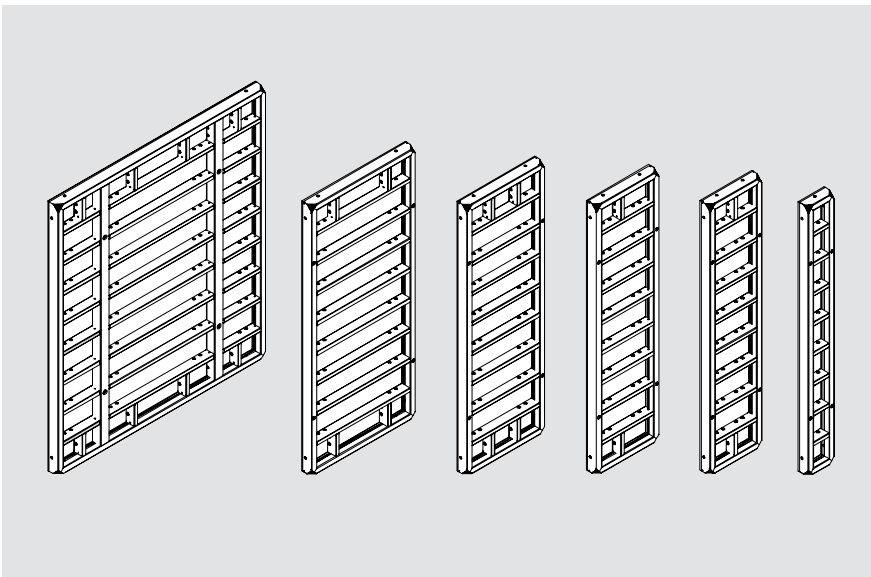

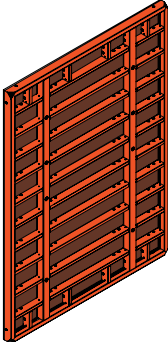







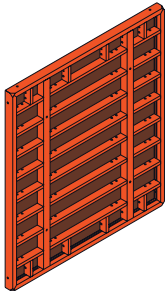







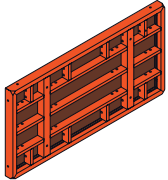













The low number of different form-work panels ensures easy handling for the construction crew. The clearly structured panel increments of 30 cm increases the utilization rate of all panels and simplifies material requirements as well as the logistics.

A further advantage: TRIO does not require any special external corner panels. The Multi Panel with its 72 cm width along with the continuous perforated anchor hole strip for corner formations can also be used in straight walls.

With only 6 panel widths, virtually all ground plans can be formed. The circumferential struts allow vertical and horizontal use of the TRIO panels and ensure rigid connections when extending.

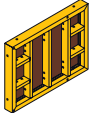
The 72 cm wide Multi Panels are used for both outside corners as well as in straight walls.



		Width								
		240	120	90	60	30	72	TE Internal Corner Angle	TRM 72 Multi Panel	TGE Articulated Corner
Height	330	 398.00 kg	 195.00 kg	 140.00 kg	 107.00 kg	 74.20 kg	 119.00 kg	 85.80 kg	 133.00 kg	 119.00 kg
	270	 329.00 kg	 162.00 kg	 115.00 kg	 87.70 kg	 60.60 kg	 97.60 kg	 69.80 kg	 103.00 kg	 94.80 kg
	120	 163.00 kg	 76.30 kg	 58.20 kg	 43.40 kg	 28.40 kg	 48.60 kg	 33.20 kg	 56.20 kg	 43.60 kg
	60		 43.40 kg	 34.70 kg	 25.90 kg	 15.70 kg	 29.10 kg	 18.00 kg		
	270			 70.60 kg	 49.60 kg	 31.70 kg		 42.10 kg	 60.90 kg	
90		 33.30 kg		 18.00 kg	 10.80 kg		 15.20 kg	 23.70 kg		

The product portfolio includes standard steel panels up to 3.30 m in height. Lightweight aluminum panels with yellow powder coating complement the range of panels.

Easy and simple connections

Only one part is required for all panel connections – the BFD Alignment Coupler

The BFD Alignment Coupler ensures that the formwork panel connections are flush, aligned and tight – in a single operation without requiring any additional accessories. This facilitates fast working operations and reduces the number of components. As a result, work preparation and material storage among other things are made easier.

The coupler can be used for virtually all connections:

- standard panel joints
- external and internal corners
- acute, obtuse and articulated corners
- stopend formwork and height offsets
- panel extensions
- compensation areas with timbers up to 10 cm wide
- combining TRIO with MAXIMO, RUNDFLEX or RUNDFLEX Plus as well as Circular Column Formwork SRS



The BFD Alignment Coupler can be operated using one hand only.

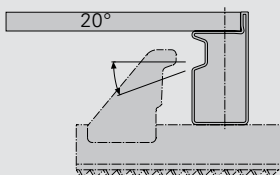

The angle of the seam is a particular feature of the BFD connection. This provides a favourable force direction when tensioning.

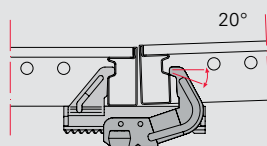

The well thought-out design and mechanics guarantees the pre-determined order of the effect for the BFD Alignment Coupler: first flush,...

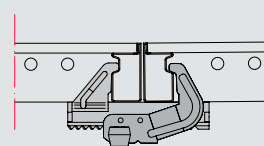

... then aligned,

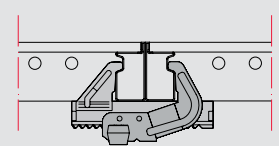

... then tight.



For extensions up to 5.40 m high, only one BFD Alignment Coupler is required due to the circumferential struts.



For connecting 2.70 m high panels, it is sufficient to use only 2 Alignment Couplers on the panel side.

Stopend formwork is also quickly and easily realised with the BFD Coupler, e.g. for a 24 cm wall thickness with the TRIO Stopend Panel.



The BFD Alignment Coupler is used both flat panel joints as well as external corners.



The BFD Coupler provides the fastest solution for filler timber compensations up to 10 cm wide.



TRIO can be combined with the further-developed MAXIMO – the BFD Coupler is the consistent connection option here as well.

Large-area shuttering

Up to 3.30m x 2.40 m standard panels

The TRIO large-sized panel with dimensions of 3.30 m x 2.40 m and 2.70 m x 2.40 m offers significant advantages for fast forming operations.

The statically favourable system ensures only small deflections. The rectangular shape of large-sized panels offers a wide range of options regarding the arrangement of the panels. When extending, a uniform joint pattern is guaranteed.

With the large-sized panels, the anchor points are arranged on the inside. As a result, stopend formwork and wall connections can easily be realized. In addition, no anchor holes have to be closed.

3.30 m high walls can be concreted with only 2 rows of anchors per panel when using the TRIO 330 – working even faster at great heights. TRIO 330 provides the best level of evenness with very high permissible fresh concrete pressures. If required, the panel can also be extended or combined with the 2.70 m high version positioned opposite.

The panels conform to common loading dimensions. With its 2.40 m width, the panels can be loaded onto all trucks.

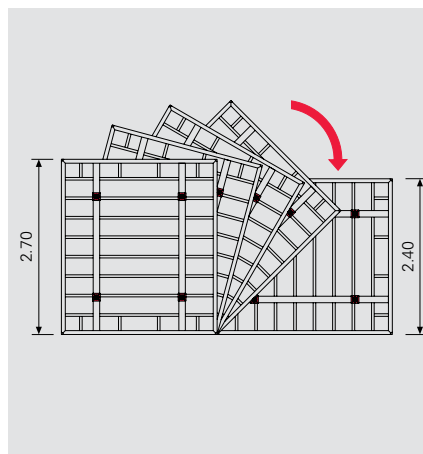

The TRIO large-sized panel can be used both horizontally and vertically.



TRIO can be extended up to heights of 5.40 m in 30 cm increments. For larger heights, a compensation water is also used.



For the 6.60 m high, massive reinforced concrete walls, the TRIO 330 was extended and supplemented with TRIO Concreting Platforms.

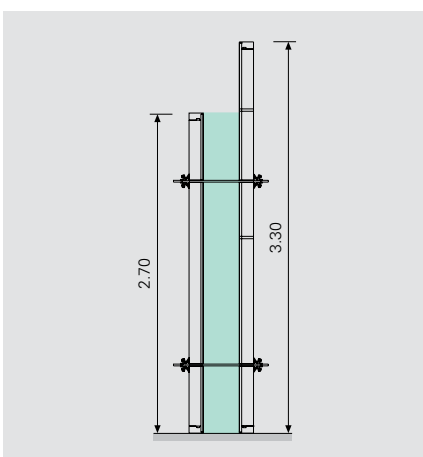

TRIO 330 and TRIO 270 can be used when positioned opposite each other.

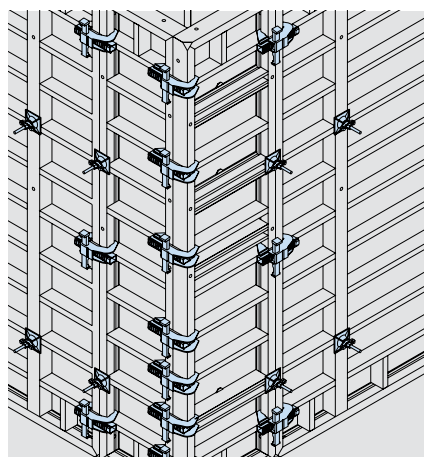

For concreting heights up to 3.30 m, only two anchors are required while three BFD Alignment Couplers are sufficient on the panel joints.



With TRIO 330, very high walls can be constructed very quickly – a 13.20 m high wall can be realized using only 4 panels.

Safe working conditions in all situations

System solutions for safe and fast work operations

For safe working with TRIO, a wide selection of accessories is available ranging from simple brackets through to complete platform systems. The focus is on fast operations and using only a minimum of individual components.

The system solutions range from holders for guardrail posts through to complete pre-assembled concreting platforms. The result: fast and efficient working in all situations.

A working and concreting scaffold is created using Scaffold Brackets TRG 80 / TRG 120. They are automatically locked in place when attached to the horizontal and vertical struts. The permissible load is 150 kg/m² with a maximum width of influence of 1.35 m.



The TRIO 120 x 270 Concreting Platform is delivered already pre-assembled. It is mounted from above on the element and is secured automatically. The permissible load is 150 kg/m².



Secured on both sides: the platform provides a working area on one side while the opposite side is secured with anti-fall protection.

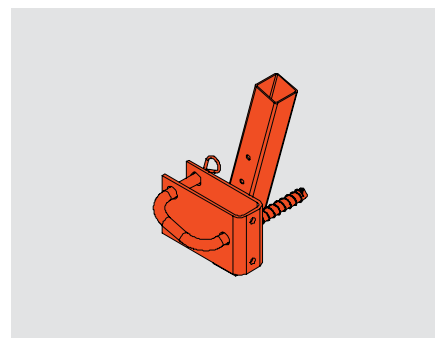

The Guardrail Post Holder TRIO is mounted on a horizontally-positioned panel. With one PROKIT Post and PROKIT Side Mesh Barrier respectively, the anti-fall protection is quickly mounted.

With the Platform System MXP, generously-sized working platforms can be realized on MAXIMO and TRIO Panel Formwork.

MXP makes a convincing case due to its high level of safety and simple site operations. Assembly by hand on the ground as well as the possibility of moving large-sized units make the system particularly cost-effective regarding high walls and multiple usage.

The standard assemblies of the MXP Platform System are 2.40 m, 1.20 m, 0.90 m or 0.72 m wide. The integrated ladder access, hatches and guardrails guarantee efficient working operations. In addition, the MXP provides quick solutions for corners, length compensations and stopend formwork. All tie rods are easy to reach from the platform.



With the MXK Bracket System, safe and comfortable working platforms are realized on MAXIMO and TRIO Panel Formwork.

In contrast to conventional solutions, the MXK has a modular design: the most important system component is the bracket; it can be completed with different types of decking and PROKIT Side Mesh Barriers to form a working platform.

The supplementary system components such as decks with access hatches, ladder access, system solutions for internal and external corners as well as length compensations ensure a consistently reliable solution in all areas.



Standard assemblies of the MXK Bracket System are realized with 2.40 m, 1.20 m or 0.90 m widths.



The working platforms are mounted on the element of the corresponding width and also remain attached to the formwork during temporary storage.

TRIO Panel Formwork at a glance





The following pages describe standard applications for the forming of walls, foundations and corners. The explanations show important basic principles but do not make any claims regarding completeness.

All detailed specifications as well as any possible country-specific data can be found in the Instructions for Assembly and Use. Furthermore, the corresponding Instructions for Use must also be observed.

Corners, compensations and wall connections

For the execution of corners of all angles, compensations and wall connections, TRIO offers quick and easy solutions. In addition, well thought-out details accelerate the work with TRIO.

TRIO does not require any special panels for rectangular external corners of walls up to 40 cm thick. For external corners, the 60 and 72 cm wide panels are used; both can also be utilized in straight walls.

Non-rectangular corners can be quickly formed with articulated system components. In the process, the same articulated corners for inside and outside reduce the number of different system components to a minimum.



Corners

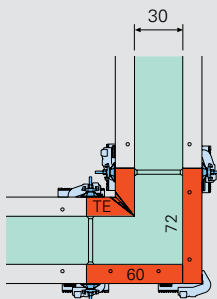

Standard corners are realized using the Internal Corner TE. Wall thicknesses from 18 cm to 40 cm can be continuously formed. If required, the Wall Thickness Compensator WDA 5/6 is used.

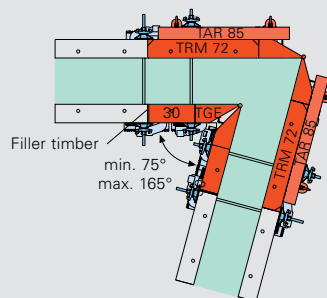

Obtuse and acute external and internal corners from 75° can be variably and quickly formed with the Articulated Corner TGE.



The TRIO Multi Panel with its 72 cm width and continuous row of holes for through-ties.

Compensations

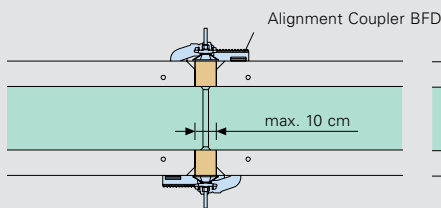

The easiest and fastest solution for length compensations up to 10 cm is realized using timbers in combination with the Alignment Coupler BFD.

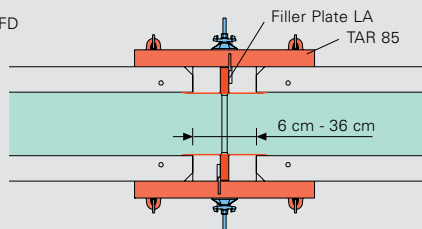

Cost-effective implementation of offsets from 6 cm to 36 cm with the Filler Plate LA and Compensation Waler TAR 85.

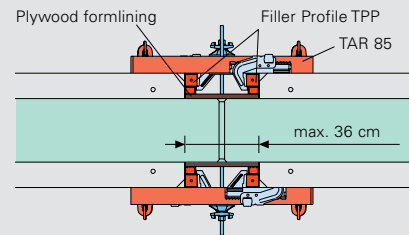

For meeting architectural concrete requirements, length adjustments from 20 cm to 36 cm are carried out with the TRIO Filler Profile and 21 mm thick formlining.

Wall connections

Also for T-Junction connections TRIO requires only a minimum of system components.

As external formwork, the 90 cm wide panel is always used for standard wall thicknesses while the TRIO Corner forms the internal formwork. For other wall thicknesses, the Wall Thickness Compensator WDA 5 and WDA 6 or timber facilitate the adaptation of the internal formwork.

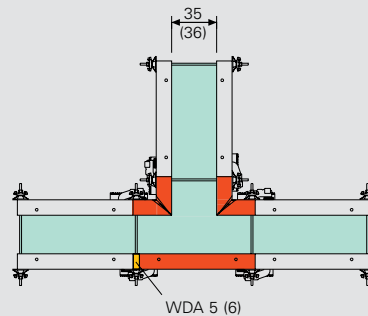

All other common wall thicknesses can be easily adapted through 5 cm or 6 cm compensations through the use of the Wall Thickness Compensators WDA.

Compensation Walers

The 85 cm long Compensation Waler is used for length adjustments, corners with large wall thicknesses, acute and obtuse corners, wall offsets as well as extensions.

The Waler guarantees a rigid, aligning and force-transferring panel connection. All required connecting parts are permanently attached to the Compensation Waler TAR 85.



Simple handling: no additional mounting parts are required.

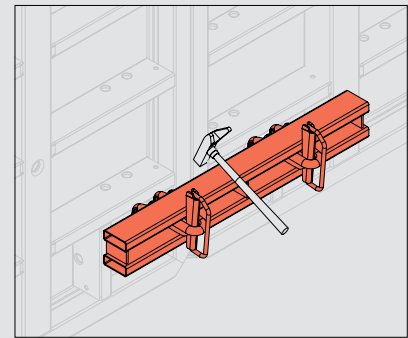

Quickly mounted: the hooks are simply inserted into the connecting holes on the panel and the wedges subsequently hammered securely in position.

Stopend formwork

Stopend formwork

For stopend formwork, a wide range of accessories is available.

From closed stopend panels and solutions with filler plates through up to panels that also allow rebar connections for the following concreting steps.



For walls with 24 cm and 30 cm thicknesses, Stopend Panels TR 24 and TR 30 are available: with the BFD Alignment Coupler, closed stopend formwork sections are possible. The panels can also be used as wall elements.



For other wall thicknesses, timber or filler plates are attached to the 85 cm long Compensation Waler and Stopend Ties in order to transfer the concrete pressure to the TRIO Panels.

TRIO Stopend Panel MT/MTF

With continuous reinforcement for the following concreting steps, the TRIO Stopend Panel MT is used. If a water bar needs to be installed at the joint, the Stopend Panel MTF provides an appropriate installation possibility.

The stopend panel is available for panel heights of 1.20 m, 2.70 m and 3.30 m.

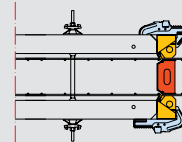

Centre Part MT
without a water bar.

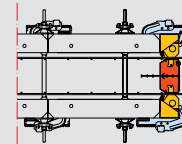

Centre Part MTF
with a water bar.

Stopend Waler MX 15-40

The fresh concrete pressure of the stopend formwork is transferred to the TRIO Panels by means of the Stopend Walers.

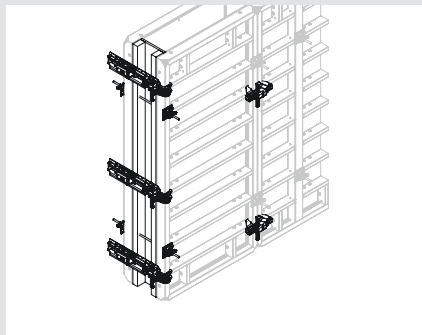

With a panel height of 2.70 m and a wall thickness ≤ 40 cm, 3 Stopend Walers are to be used for a permissible fresh concrete pressure of 60 kN/m².

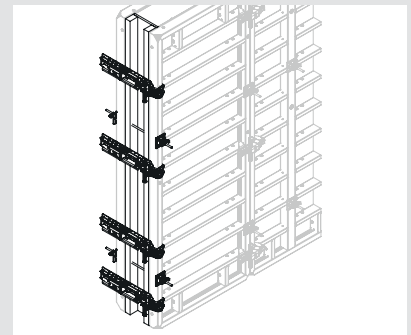

With a panel height of 3.30 m and a wall thickness ≤ 40 cm, 4 Stopend Walers are to be used for a permissible fresh concrete pressure of 60 kN/m².

Shuttering and striking in just a few simple steps

Useful accessories

Numerous other details facilitate fast and safe forming with TRIO; practical accessories guarantee easy and simple handling.

TRIO Panels have pairs of holes on each strut with securely-fitted sleeves. Accessories such as push-pull props or concreting scaffold can be friction-locked in position.

In addition, specially developed tools accelerate daily shuttering and striking operations.



By means of the levering corner, exact panel positioning can be achieved without requiring a hammer. This is particularly easy when using the stripping bar.



Panels can be released more easily and without damage with the stripping bar. The guide roller also prevents damage to the concrete wall.



The anchor key is used for easy tightening and loosening of the wingnuts without a hammer which is much less time-consuming especially for the top tie positions.



The Tie Rod Wrench greatly simplifies anchor point operations.

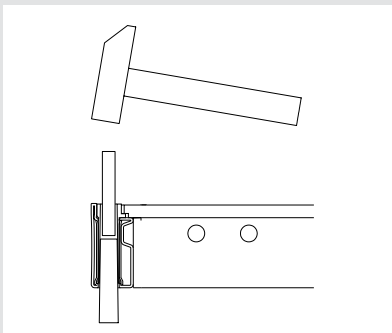

If anchor holes in the panels are plugged with concrete, these can easily be freed with one blow of a hammer thanks to the conical shape of the plastic sleeves.



Connection possibilities for Scaffolding Brackets, Push-Pull Props and other accessories offer are provided on the vertical struts...



... as well as the horizontal struts.

Crane-independent working with TRIO Alu

The TRIO Alu is the lightweight version for crane-independent work operations. For easy identification purposes, the panels are yellow powder-coated.

TRIO Alu panels are available in the following dimensions: height 270 cm and widths 90, 60, 30 and 72 cm as well as height 90 cm and widths 120, 60, 30 and 72 cm.

TRIO Alu is compatible with the steel version, and the panels can be used as an independent system as well as a supplement to the steel panels. The same accessories can be used on both variants.



If no crane is available, the TRIO Alu offers a lightweight alternative which can easily move by hand.

The steel and aluminium panels can be combined as required. Thanks to the different coloured coatings, the panels can easily be identified.



TRIO Structure with any selected formlining for special surface requirements

The TRIO Structure variant allows the realization of special concrete surfaces. The TRIO frame element comes complete with a fixing board that can be covered with profile boards.

TRIO Structure is available in heights of 1.20 m, 2.70 m and 3.30 m. Special dimensions can also be ordered on request.

With an overall height of only 14 cm, TRIO Structure has around 60 % less height than girder wall formwork which is used as an alternative for special surface requirements. As a result, TRIO Structure saves on both transport and storage costs.

The factory-made fixing board is 21 mm thick. At the customer's request, PERI also delivers TRIO Structure pre-assembled or for on-site assembly complete with accurate cut-to-size formlining. When mounting at the front, the formlining is installed using screw nails while when assembling at the rear, Torx screws are screwed through the TRIO Structure fixing board.



With TRIO Structure, SB 3 architectural concrete requirements are fully met. The OSB sheets and FinPly formlining were neatly screwed on at the rear.



TRIO Structure is a variant of the proven panel formwork system and can be used with the complete range of TRIO accessories.



TRIO Structure can be fitted with a range of different sheeting and surfaces which allows considerable scope for design purposes.



TRIO Structure can be combined with standard TRIO Panels. This is a great advantage as special surfaces are often required only on one side.



TRIO Structure being used to form a bridge pier:
being covered with additional strips of wood results
in an interesting surface structure.

Moving complete shaft internal formwork units with the Shaft Panel TSE and Shaft Corner TRIO

The TRIO Shaft Panel facilitates fast striking and moving of shaft internal formwork units.

The Shaft Panel is available in heights of 1.20 m, 2.70 m and 3.30 m. It is installed between two TRIO Panels.

Thanks to the ingenious design, the inner formwork dimensions are reduced when lifting the Shaft Panels. The all-round striking clearance of 3 cm provides enough space to easily and quickly move the complete unit.

The size of the shaft is basically of no importance when using the Shaft Panel. Constructively, this results in a minimum edge length of 1.30 m. The maximum load-bearing capacity of 2,000 kg per Shaft Panel must be taken into consideration.

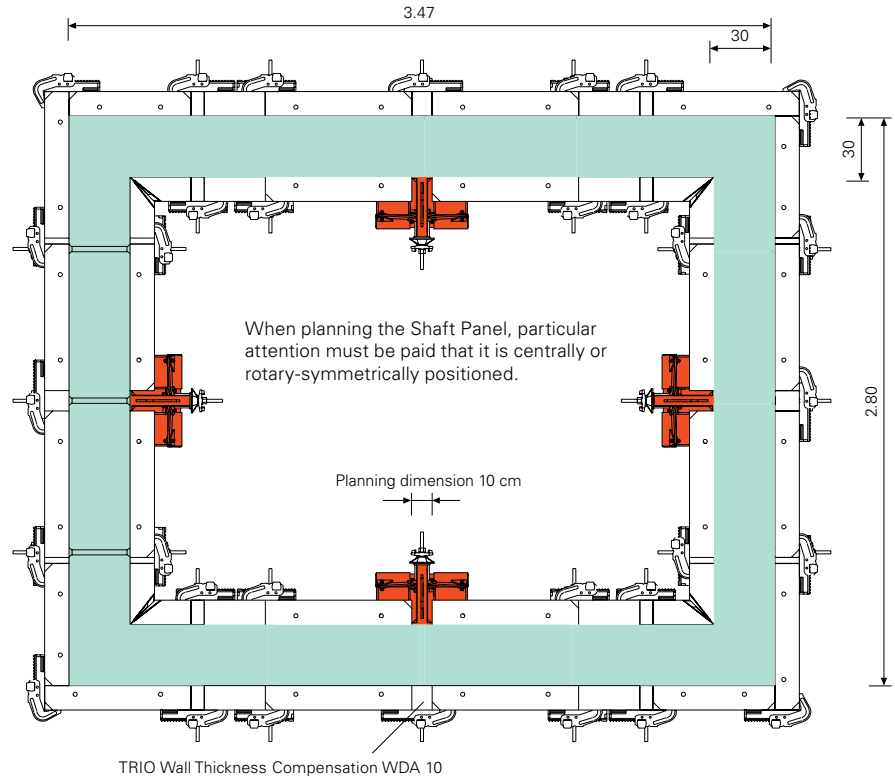

When striking, the crane slings are attached to all four Shaft Panels and the formwork panel is brought into the striking position by means of levering.



After being lifted by crane, the Shaft Panel TSE is released resulting in the required striking clearance.



Rectangular shafts require adjustable crane slings due to the different lengths of the attachment points. This results in approximately the same tensile force on all four slings.



When pulling the Shaft Panels, a striking clearance of 3 cm is provided on each side, and the complete unit can be moved in one crane lift.



Clearly visible is the striking clearance of approx. 3 cm wide. The Shaft Panel itself remains close to the concrete thus allowing better guidance.

Shaft Corner TRIO 330

Shaft with two Shaft Corners

The striking dimensions are reduced by 17.5 mm on each side of the shaft.

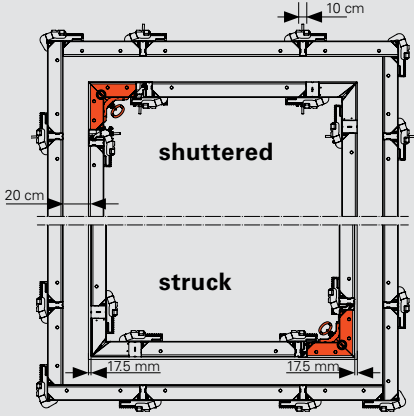

Shaft with four Shaft Corners

The striking dimensions are reduced by 35 mm on each side of the shaft.

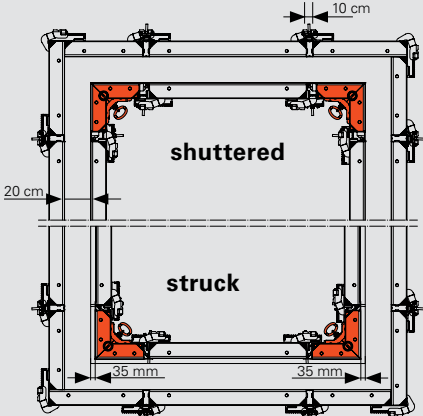

The Shaft Corner TRIO 330 can also be used with 2.70 m high panels.

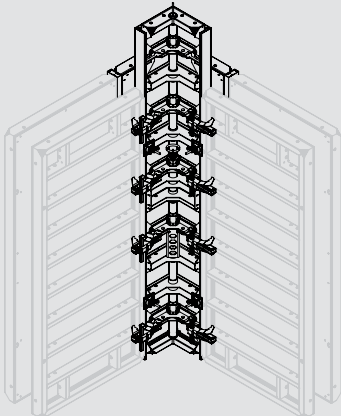

TRIO Column Formwork – for square and rectangular columns

With the supplementary TRIO Column Panels, square and rectangular-shaped columns can be realized. The 90 cm wide panels can also be used in wall construction.

TRIO Column Formwork complements TRIO Wall Formwork. Cross-sections up to 75 cm x 75 cm can be formed in 5 cm increments. With panel heights of 60 cm, 1.20 m and 2.70 m, 30 cm height increments are realized.

A fast solution for the best-possible column edges is provided by the chamfer strip with its 15 mm edge length: it is simply placed on the column panel and is thus connected to the panel without any other additional means.

Safe access to the formwork is provided by the continuously adjustable concreting platform and access ladder with Ladder Safety Cage.



Regardless whether square or rectangular-shaped, columns up to 75 cm x 75 cm in 5 cm increments are possible with TRIO Column Panels.

Simple mechanics eliminates time-consuming nailing: the chamfer strip is simply placed in position and results in clean column edges.

The concreting platform continuously adapts to every cross-section up to 75 cm x 75 cm. It can be combined with RAPID and QUATTRO Column Formwork.

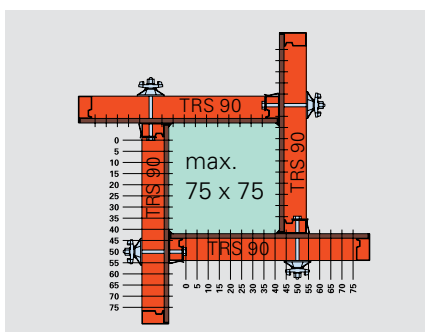



With 3 heights, columns in 30-cm height increments can be constructed. BFD Alignment Couplers connect the column panels when extending.

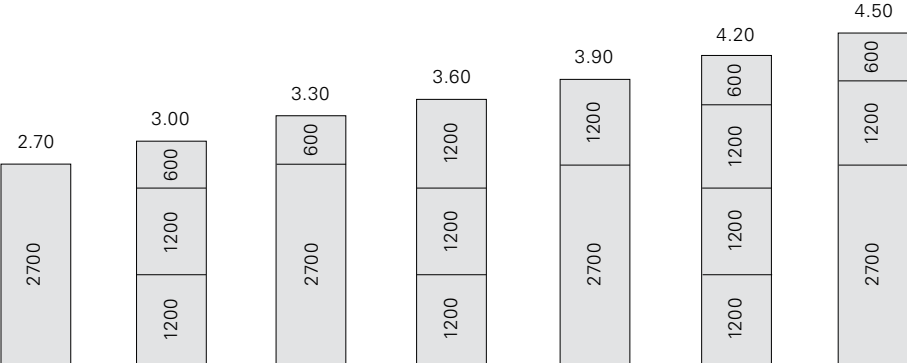

PERI Push-Pull Props for aligning and supporting the wall formwork



For supporting the wall formwork, PERI offers a complete Push-Pull Prop programme. The Push-Pull Props meet the requirements for a long service life, low maintenance costs and fast handling.

The Push-Pull Prop RS is galvanized and can be telescoped. With a total of 7 different Push-Pull Props, a range of lengths from 1.30 m up to 14.00 m is available. Rough adjustment in 10 cm increments is possible in seconds due to the telescoping function. By using the spindles at the end of the inner tubes, fine adjustments can take place with a minimum of turns.

The Push-Pull Props RS 210 to RS 650 can be handled – regardless of the required extension length – from the assembly area. For this, the RS 650 also has a chain guide which makes attaching and releasing the lifting chains possible without a ladder.

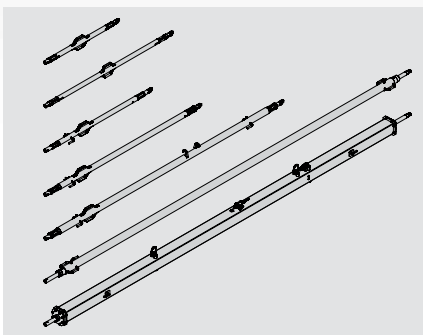

Up to 14.00 m support lengths are possible with the PERI Push-Pull Prop programme. Simple length adjustment thanks to the telescoping function and spindles.

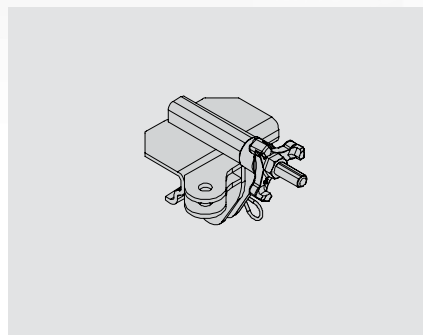

With the Brace Connector TRIO, it is possible to attach the Push-Pull Props and Kickers to horizontal and vertical panel struts.

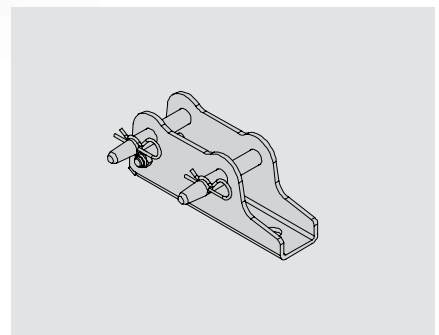

The Base Plate is fixed to the concrete, e.g. with PERI Anchor Bolts. The two bolts of the Base Plate are used for connecting the Push-Pull Props and Kickers.

PERI Brace Frames – the solution for single-sided walls up to 8.75 m high

With the SB Brace Frame, the concrete pressure is transferred through the sub-structure during single-sided concreting – up to 8.75 m high and maximum 60 kN/m² concrete pressure.

All SB Brace Frame units can be quickly coupled without any additional parts; the required connecting materials are securely mounted on the Brace Frame.

The Brace Frames are mounted on the panels positioned on the ground. The nature of the connection allows them to be lifted as a single unit.

During operations on a concreted bottom slab or foundations, the transfer of compression forces can normally take place without any difficulty. For dealing with the forces that are generated, PERI offers various systems for tension anchoring to the sub-structure.



Friction-locked connections allow complete units to be moved.



SB-B and SB-C Brace Frame units with TRIO Panel Formwork with a concreting height of 3.50m.

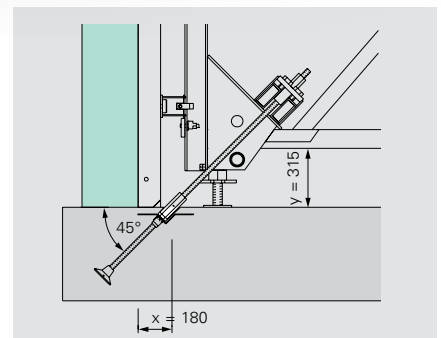

The choice of the most suitable anchoring system is determined by the tensile force applied on the Brace Frame.

TRIO for the construction of foundations

As foundations usually have only low heights, TRIO Panels are used here horizontally. For anchoring the Panels, appropriate accessories are to be used.

The size of the foundations does not matter. With Foundation Straps, Top Tie Brackets and Foundation Tie Clamps, foundations can be continuously formed with TRIO.

The Tension and Compression Brace can also be used to form foundations, parapets or beams.

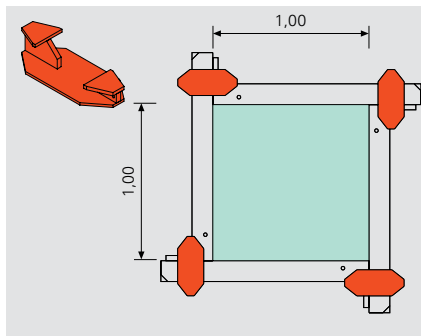

The Foundation Strap TRIO is used for forming individual foundations using the "windmill configuration". The locating board can be fixed using nails.



The Top Tie Bracket allows grid-independent anchoring outside of the panel. As a result, it is used for foundations and extensions.

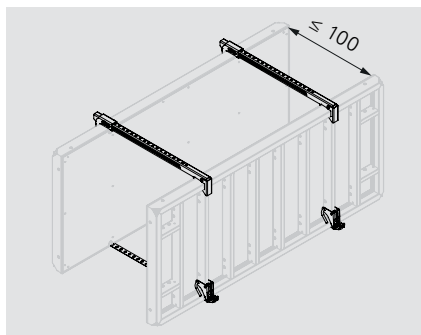

The Tension and Compression Brace is available in two lengths: the MX 15 - 40 is continuously adjustable in 5 cm increments for 40 cm; the MX 15-100 accordingly up to 100 cm.



If the bottom tie positions in the strip and individual foundations are missing, the Foundation Tie Clamp with Perforated Foundation Tie are used.

TRIO for use with polygonal walls

Polygonal structures can also be formed with TRIO by using the corresponding panel widths and filler timber. Anchoring takes place through the filler timber.

In order that the effectiveness of the Alignment Coupler BFD is not affected, the panels may deviate from the centre by a maximum of 2.6° . The filler timber width of the internal compensation must be at least 4 cm while the external compensation is a maximum 10 cm.

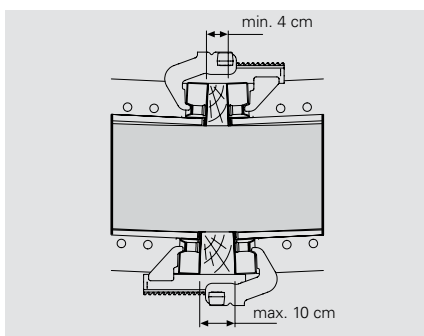

TRIO in use

From a single-family house to climbing operations



Residential Building Neuperlach, Munich, Germany



Palm Paper Newsprint Paper Plant, King's Lynn, Great Britain



King Hussein Clinic, Amman, Jordan

Versatile use for walls, columns and foundations

The three-storey residential complex in the Munich suburb of Neuperlach contains a total of nine apartments with 80 m² to 150 m² living space. The cellar areas and an underground parking facility are accommodated in the basement.

For the basement and ground floor, a total of 157 linear metres of reinforced concrete walls were cost-effectively constructed using TRIO Panel Formwork. Concreting of the 25 cm thick and 2.92 m high shear walls was carried out extremely flexibly with close to 200 m² set of formwork and could easily be adapted to suit site requirements. For forming the almost 3 m high walls, the TRIO 270 Panels were simply extended with narrow, primarily 30 cm wide panels positioned horizontally.

Fast forming of high walls

Europe's largest and most modern paper factory is located 150 km north-east of London. For the realization of the 600 m long, 100 m wide and 30 m high facility, building shell construction was closely with the machine assembly operations.

With TRIO 330, a 9.90 m high wall could be quickly and cost-effectively formed thanks to fewer individual components and universally applicable BFD Alignment Coupler.

Flexible for different wall heights

The newly constructed medical centre is situated on a ridge close to the Jordanian state capital and the Dead Sea. The 7-storey main building has a surface area of 170 m x 200 m and is 30 m high.

The reinforced concrete walls with heights of between 4.95 m and 6.60 m were formed with TRIO Panel Formwork. In addition, the TRIO 240 x 330 large-sized panels could be used both vertically and horizontally.



Kurnell Desalination Plant, Sydney, Australia



The Temple, Warsaw, Poland



Donau City Tower 1, Vienna, Austria

Combined with modular PERI system equipment

A total of four contractors were responsible for completion of the Kurnell desalination plant in Sydney, Australia – the formwork solution for all partners was supplied by PERI. With the TRIO Wall Formwork System, the massive 18.50 m high reinforced concrete walls with thicknesses between 0.80 m and 1.50 m could be flexibly and efficiently formed. At the same time, the PERI formwork planning took into consideration the various height offsets and wall sections which were constructed using single-face forming operations.

For the concreting sections at great heights, TRIO together with the CB Climbing System were used - with help of SKS Brackets, single-sided climbing could then be carried out. Here, the concreting cycle height was 3.00 m in each case.

System solutions for complex requirements

The “Temple of the Divine Promise” is considered to be the most important ecclesiastical building of the last three centuries in Poland. The construction consists of reinforced concrete frames arranged in circle which carry a huge dome – the overall height of the church is 75 m. The nave has a diameter of 68 m and consists of two rings of columns.

Climbing units based on KG Climbing Scaffold and TRIO Panel Formwork were used to construct the load-bearing reinforced concrete columns of the outer ring. For forming the concrete columns of the inner ring, TRIO TRS Column Panels together with pre-assembled box-outs were employed. The temple walls were constructed using TRIO Panel Formwork, VARIO GT 24 Girder Formwork along with RUNDFLEX. Rentable formwork and scaffolding systems as well as project-specific special constructions were ideally combined.

High, slender and very distinctive – safely and quickly climbed

With a height of 220 m, the Donau City Tower 1 in Vienna is the highest building in Austria. For the extremely slender city landmark, PERI developed a comprehensive formwork and scaffolding solution in close cooperation with the project management – using a combination of ACS Self-Climbing Technology, TRIO Panel Formwork, and the RCS Climbing Protection Panel.

For constructing the three core areas of the DC Tower, ACS Self-Climbing Technology in combination with TRIO Panel Formwork was used. The three areas were climbed independently of each other up to a height of 220 m. A 3.50 m concreting section was realized by the construction team in 4 days. The RCS Climbing Protection Panel could be flexibly adapted to suit the forward and reversed-inclinations of the facade geometry, secured by sliding scaffold elements.

TRIO in use

From complex shapes to infrastructure buildings



Prosta Tower, Warsaw, Poland



Office Building, Boulogne-Billancourt, France



St. Martins Therme & Lodge, Frauenkirchen, Austria

Realising flexible forms

A building front made of glass and a lozenge reinforced concrete structure in perfect architectural concrete characterizes the 70 m high Prosta Tower in Warsaw's city centre. The delicate concrete facade was installed in the form of a net over the external glazing but still serves as a structural component.

The TRIO Panel Formwork served as an inexpensive as well as a simple and quick to assemble basic form with a formworking height of 3.60 m. Double-layered Fin-Ply Maxi formlining provided attractive and virtually joint-free concrete surfaces. Due to the special panel arrangement as well as the use of load-distributing Steel Walers, anchoring did not have to take place through the concrete itself. For millimetre-exact shaping of the structure, 28 project-specific box outs were designed and subsequently delivered ready-to-use to the jobsite. The basis for this was formed by rentable system components such as Steel Walers, Heavy-Duty Spindles and standardized connecting means from the PERI product portfolio. Equipped with a specially-designed striking mechanism, all standard and special cross-sections could be constructed without damaging the formwork and concrete surface during striking.

Safe and economical with TRIO customised panels

The four-storey office building in the Paris suburb is 100 m long and stands out due to its inclined external facade. While the top floor is constructed in a straight line, and thus parallel to the road, the ground floor has been offset by 4.60 m to the centre. In the centre of the building, the reinforced concrete wall has a 33° reverse inclination stretching over the two middle floors.

For cost-effective and safe construction, the building site team used TRIO Panel Formwork installed on a MULTI-PROP load-bearing system and complemented by PERI safety systems. Project-related TRIO made-to-measure panels in the area of the inclined edge of the facade ensured that no time-consuming adjustment work was necessary on site. This significantly accelerated the construction progress and was thus the most cost-effective variant.

Structural work in record time

In Austria, an exceptional thermal spa facility was created - the shell of the complex building was realized in a record-breaking short construction period of only 9 months. The spiral-shaped thermal bath complex was a challenge for site personnel as well as the formwork technology itself.

The circular, 40 cm thick reinforced concrete walls were polygonally formed using TRIO 120 Panels and trapezoidal-shaped filler timbers. PERI UP, combined with HD 200 Heavy-Duty Props, served to transfer both the concreting and the live loads during construction of the wall sections at heights of 10 m to 16 m.



CaixaForum Saragossa, Spain

Spectacular building structure

For constructing the sculpture-like „CaixaForum“ in Spain, ideally combined formwork and scaffolding systems formed the basis for ensuring efficient and cost-effective construction work: precisely adapted to match the complex building architecture as well as the high quality and safety requirements.

The four-storey building extends majestically upwards, supported by angularly arranged, up to 37 m high shear walls. Some of the walls in the bottom third of the structure are obliquely constructed with 50-degree angles, resulting in upper floor cantilevers of up to 15 m above the ground. CB 240 Climbing Brackets were connected with TRIO Panel Formwork to form large-sized climbing formwork units. The reinforced concrete walls were constructed with TRIO Panel Formwork using 4.80 m concreting cycle heights.



Lurberria Dam, St Pée Sur Nivelles, France

Flexibility and safety in dam construction

The dam in the French Pyrenees is 320 m long and 22 m high. For adapting to the different building geometries, the PERI formwork and scaffolding solution was based on flexible and modular systems. As a result, the strict safety regulations could be followed as well as guaranteeing problem-free construction progress.

In concreting cycle heights of 3.30 m, TRIO Panel Formwork together with SKS 180 Climbing Brackets were climbed from cycle to cycle. For constructing the massive 6 m high bottom plate, TRIO 330 and TRIO 270 were combined and the loads safely transferred via SB Brace Frames to the ground. Likewise, the return walls of the 27 m high discharge facility could be efficiently formed with TRIO; support was provided here with CB 240 Climbing Brackets. Four working levels provided safe conditions for shuttering and striking operations with the 5,35 m standard cycle height as well as risk-free concreting work, which resulted in fast construction progress.



Vistula Bridge, Kwidzyn, Poland

Bridge pylons crane-independently formed

With the help of PERI modular solutions for all formwork and scaffolding tasks, the Vistula Bridge could be realized within a very tight construction schedule – largely independent of crane and weather.

The Vistula crossing near Kwidzyn extends over a total length of almost 12 km. The most important components are the 808 m long main bridge and three foreland bridges. For the bridge pylons, the TRIO Formwork was climbed using the RCS Rail-Guided Climbing Technology – thanks to the mobile RCS Self-Climbing Devices without a crane and regardless of wind and weather.

TRIO Panel Formwork

Item no. Weight kg

054304 399.000

Panel TR/4 330 x 240

Steel panel with 18 mm plywood.

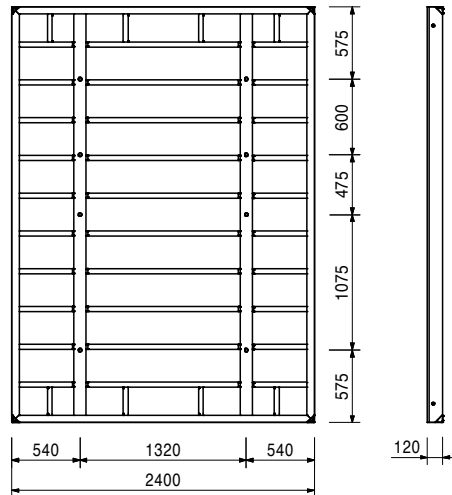
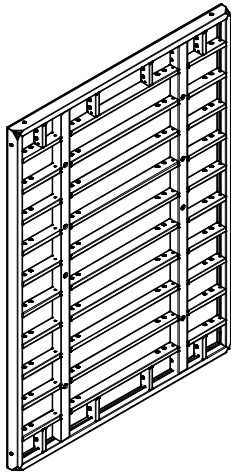

054314 196.000

Panel TR/4 330 x 120

Steel panel with 18 mm plywood.

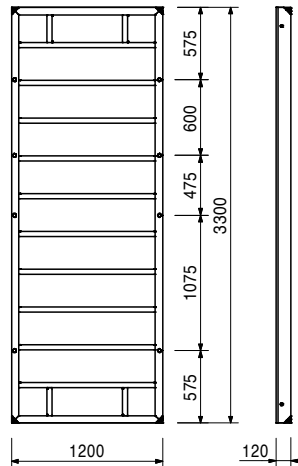
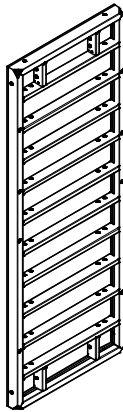

054324 138.000

Panel TR/4 330 x 90

Steel panel with 18 mm plywood.

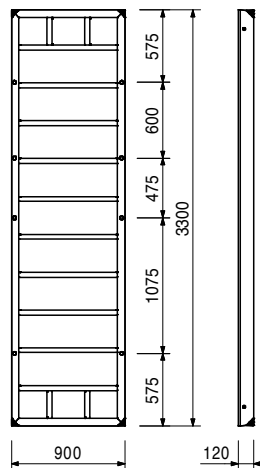
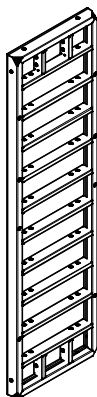

TRIO Panel Formwork

Item no.	Weight kg
054334	118.000

Panel TR/4 330 x 72
Steel panel with 18 mm plywood.

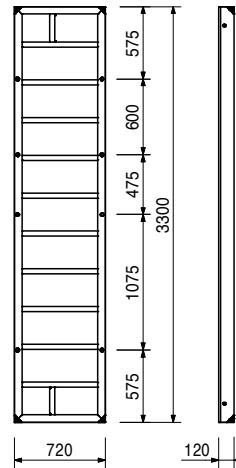
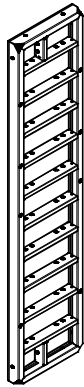

054354	106.000
--------	---------

Panel TR/4 330 x 60
Steel panel with 18 mm plywood.

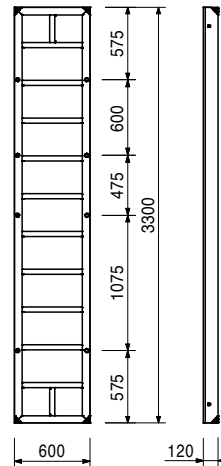
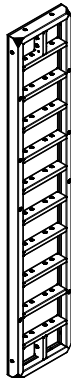

054364	73.400
--------	--------

Panel TR/4 330 x 30
Steel panel with 18 mm plywood.

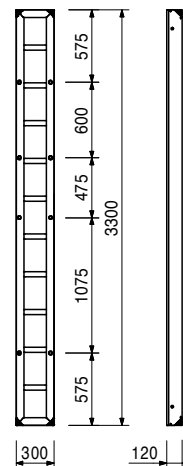

TRIO Panel Formwork



Item no.	Weight kg
054344	134.000

Multi Panel TRM/4 330 x 72
Steel panel with 18 mm plywood. For oblique angles, wall connections etc.

Complete with
88 pc. 030300 Plug \varnothing 20/24 mm

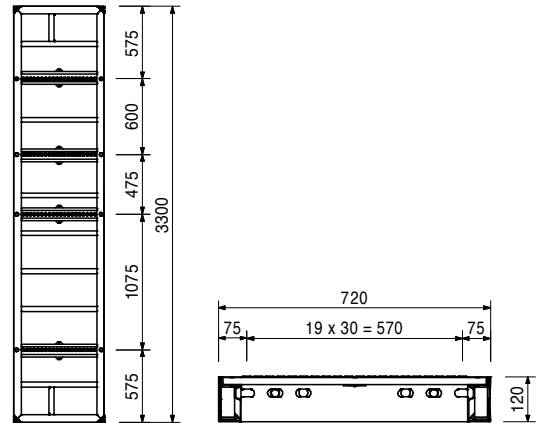
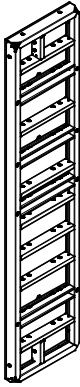

054374	85.800
--------	--------

Inside Corner TE/4 330
Steel panel with 18 mm plywood. For 90° internal corners.

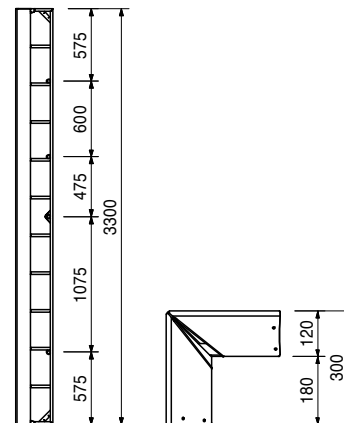
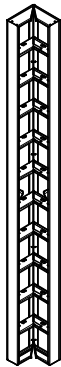

054414	119.000
--------	---------

Articulated Corner TGE/4 330
Steel panel with steel formlining. For oblique angles from 75° upwards, used externally and internally.

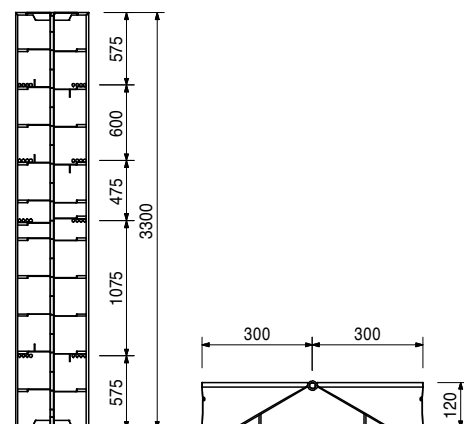
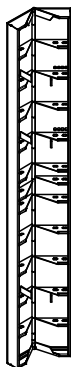

TRIO Panel Formwork

Item no.	Weight kg
129945	293.000

Striking Corner TRIO 330/270

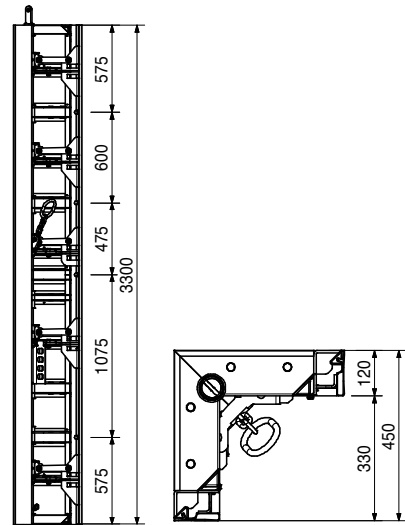
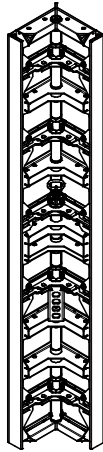

			B
054391	20.100	Wall Thickness Comp. WDA/4 330	50
054401	21.400	Wall Thickness Comp. WDA/4 330 x 5	60
054435	12.400	Wall Thickness Comp. WDA/4 330 x 6	100
		Wall Thickness Comp. WDA/4 330 x 10, Alu	
For adjusting to wall thicknesses.			

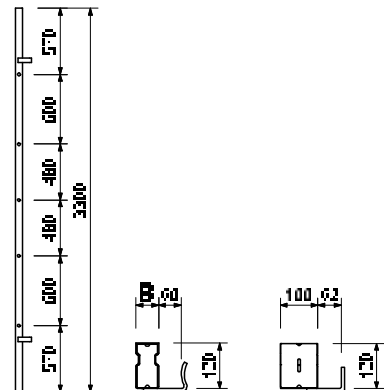

Item no.	Weight kg
105525	142.000

Shaft Element TSE 330

Panel for moving complete shaft internal formwork.

Complete with

7 pc. 105400 Pin Ø 20 x 140, galv.
7 pc. 018060 Cotter Pin 4/1, galv.

Technical Data

Permissible load-bearing point capacity 2.0 t.

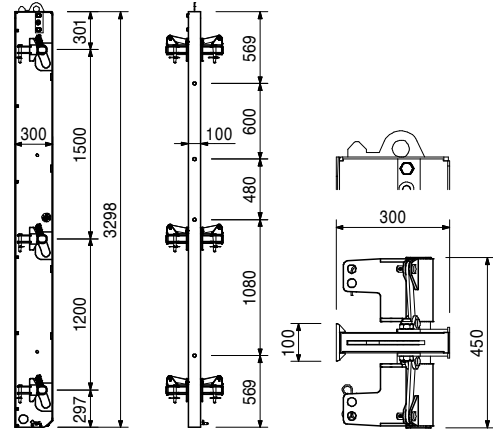
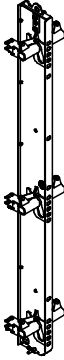

023050	62.300
--------	--------

Stopend Panel TR/4 330 x 24

Steel panel with 18 mm plywood.

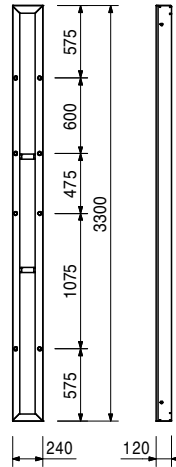

Item no.	Weight kg
054384	62.200

Filler Plate LA/4 330 x 36

For continuous compensations from 6 to 36 cm.

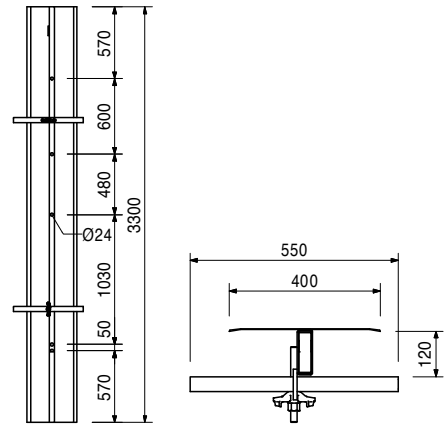
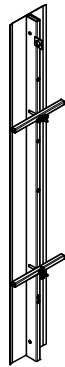

054430	6.400
--------	-------

Filler Support TPA 330

For compensations with 21 mm filler plates.

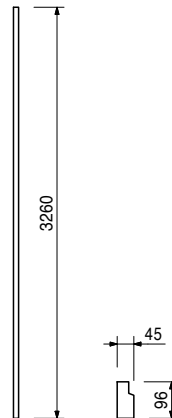

101829	9.820
--------	-------

Filler Profile TPP 330, Alu

For compensation with 21 mm filler plates.

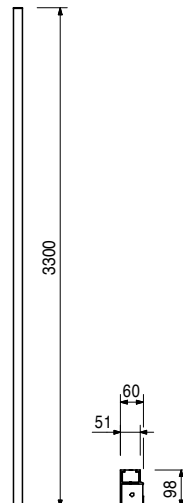

Item no.	Weight kg		B
131152	32.400	Stopend Panels TRIO MT without waterstop	118
131155	37.200	Stopend Panel TRIO MT 330 x 20	158
131158	44.500	Stopend Panel TRIO MT 330 x 30	218
131161	50.500	Stopend Panel TRIO MT 330 x 35/36	268

Without waterstop bar installation for stopend formwork.

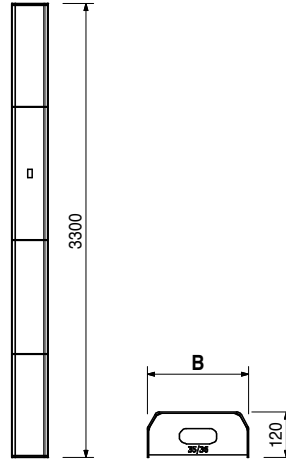

Item no.	Weight kg		B
131165	35.600	Stopend Panels TRIO MTF with waterstop	118
131169	40.900	Stopend Panel TRIO MTF 330 x 20	158
131173	46.900	Stopend Panel TRIO MTF 330 x 30	218
131177	52.000	Stopend Panel TRIO MTF 330 x 35/36	268

Centre piece with waterstop bar installation for stopend formwork.

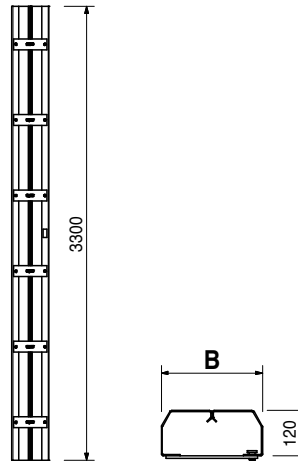

TRIO Panel Formwork

Item no.	Weight kg
131147	21.000
131149	23.200

Stopend Panels TRIO AT
Stopend Panel TRIO AT 330 x 3
Stopend Panel TRIO AT 330 x 5
 External piece for stopend formwork.

Note
 Concrete cover approx. 30 or 50 mm.

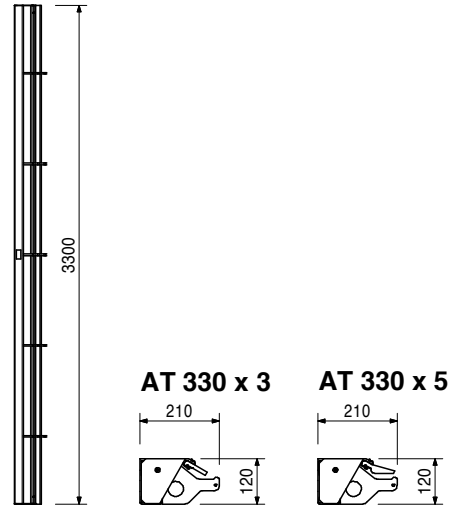

022570	330.000
--------	---------

Panel TR 270 x 240
 Steel panel with 18 mm plywood.

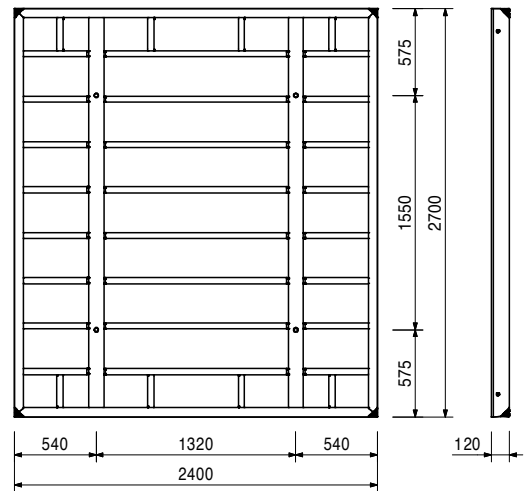
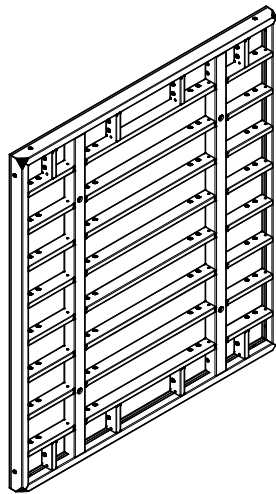

TRIO Panel Formwork

Item no.	Weight kg
022510	162.000

Panel TR 270 x 120
Steel panel with 18 mm plywood.

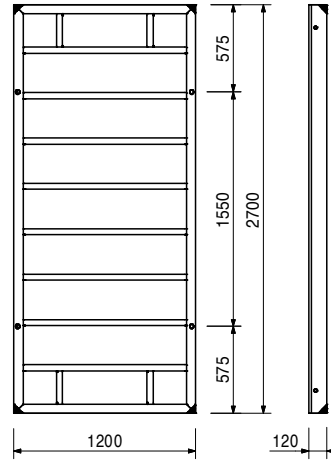
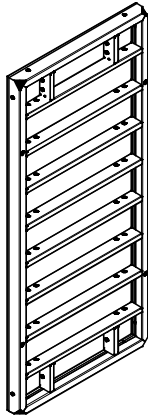

022520	114.000
--------	---------

Panel TR 270 x 90
Steel panel with 18 mm plywood.

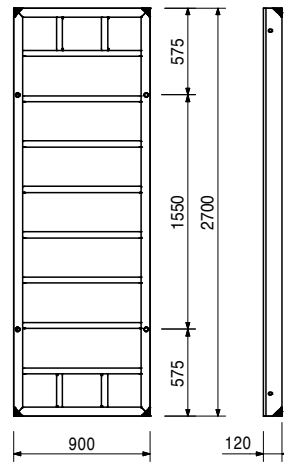
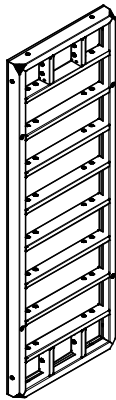

022530	97.200
--------	--------

Panel TR 270 x 72
Steel panel with 18 mm plywood.

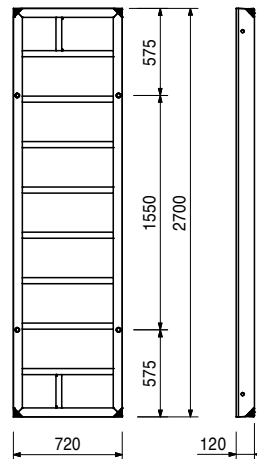
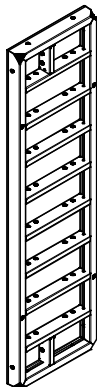

TRIO Panel Formwork



Item no.	Weight kg
022550	87.400

Panel TR 270 x 60
Steel panel with 18 mm plywood.

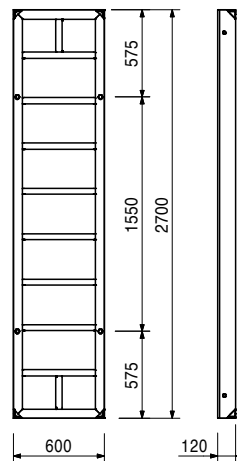
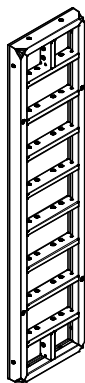

022560	59.500
--------	--------

Panel TR 270 x 30
Steel panel with 18 mm plywood.

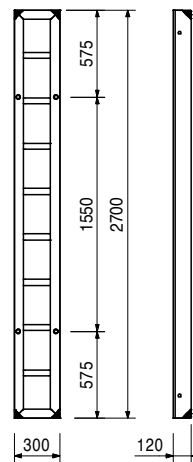

022540	103.000
--------	---------

Multi Panel TRM 270 x 72
Steel panel with 18 mm plywood. For oblique angles, wall connections etc.

Complete with
44 pc. 030300 Plug Ø 20/24 mm

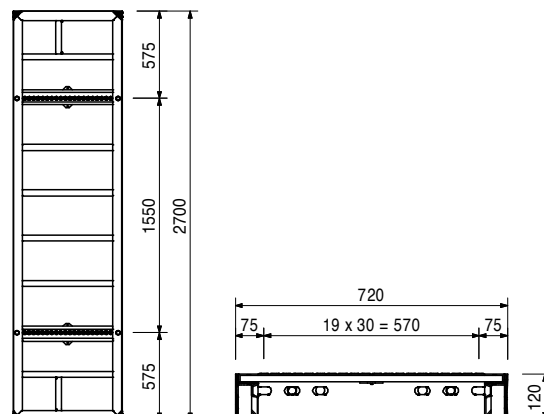
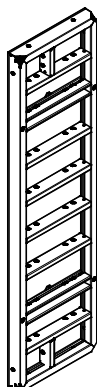

Item no.	Weight kg
022580	70.000

Inside Corner TE 270-2

Steel panel with 18 mm plywood. For 90° internal corners.

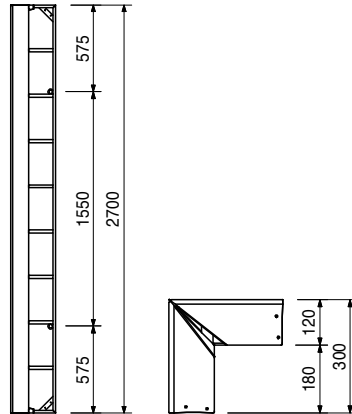
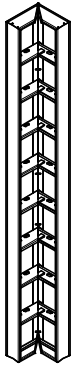

103317	56.900
--------	--------

Internal Corner TEI 270/135°

Steel panel with 18 mm plywood. For 135° internal corners.

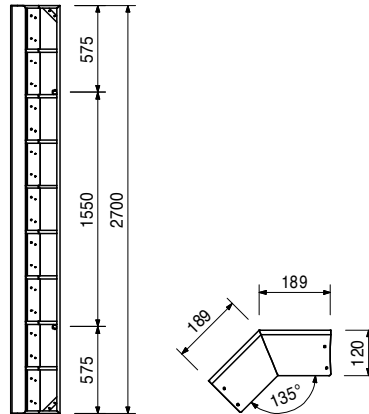
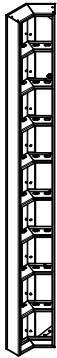

103337	76.500
--------	--------

Outside Corner TEA 270/135°

Steel panel with 18 mm plywood. For 135° external corners.

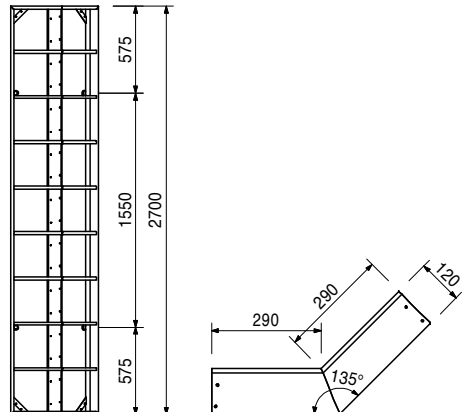
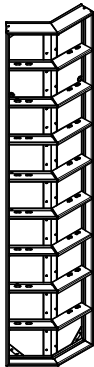

Item no.	Weight kg
023200	94.900

Articulated Corner TGE 270

Steel panel with steel formlining. For oblique angles from 75° upwards, used externally and internally.

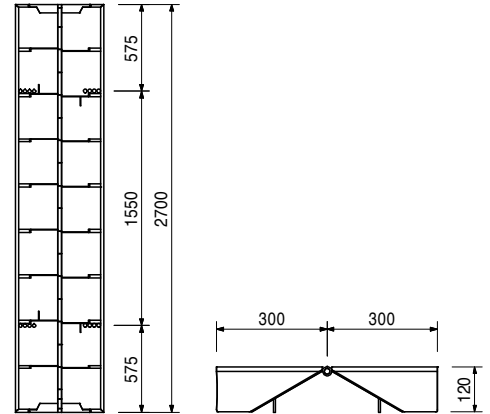
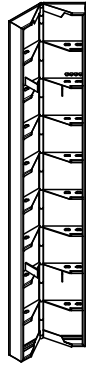

023040	50.500
--------	--------

Stopend Panel TR 270 x 24

Steel panel with 18 mm plywood.

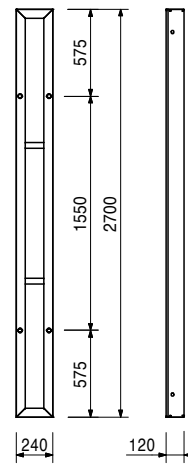

Item no.	Weight kg
105523	127.000

Shaft Element TSE 270

Panel for moving complete shaft internal formwork.

Complete with

7 pc. 105400 Pin Ø 20 x 140, galv.
7 pc. 018060 Cotter Pin 4/1, galv.

Technical Data

Permissible load-bearing point capacity 2.0 t.

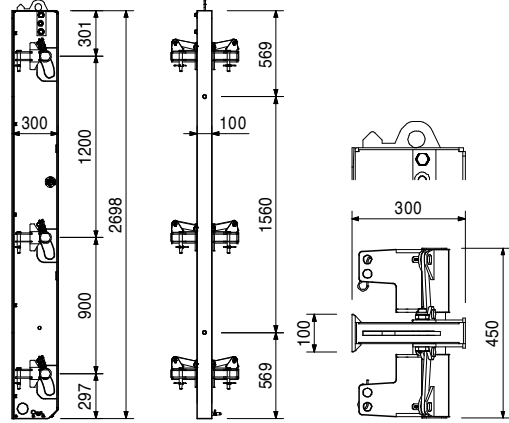
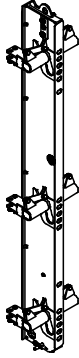

023182	16.200
023192	17.200
023995	10.100

Wall Thickness Comp. WDA 270

Wall Thickness Comp. WDA-2 270 x 5

Wall Thickness Comp. WDA-2 270 x 6

Wall Thickness Comp. WDA 270 x 10, Alu

For adjusting to wall thicknesses.

B

50

60

100

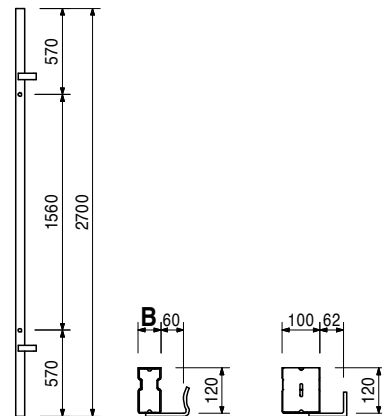

Item no.	Weight kg
023170	48.900

Filler Plate LA 270 x 36

For continuous compensations from 6 to 36 cm.

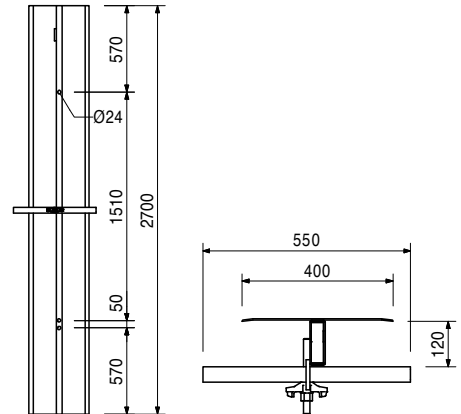
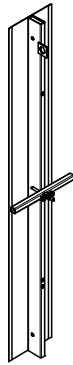

023460	4.710
--------	-------

Filler Support TPA 270

For compensations with 21 mm filler plates.

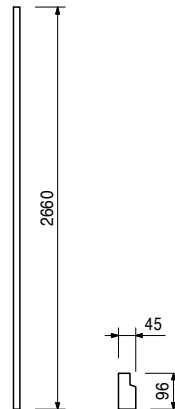

101813	8.040
--------	-------

Filler Profile TPP 270, Alu

For compensation with 21 mm filler plates.

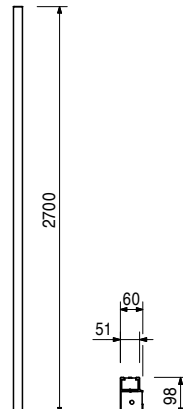

TRIO Panel Formwork



Item no.	Weight kg		B
023061	26.500	Stopend Panels TRIO MT w/o waterstop bar	
		Stopend Panel TRIO MT 270 x 20	118
023062	30.400	Stopend Panel TRIO MT 270 x 24/25	158
023064	36.300	Stopend Panel TRIO MT 270 x 30	218
023065	41.300	Stopend Panel TRIO MT 270 x 35/36	268

Centre piece without waterstop bar installation for stopend formwork.

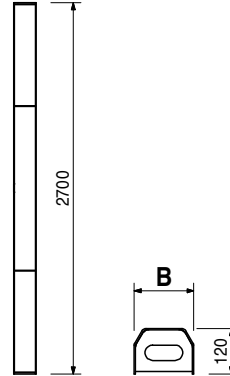

023074	29.200	Stopend Panels TRIO MTF w. waterstop bar	B
		Stopend Panel TRIO MTF 270 x 20	118
023075	33.400	Stopend Panel TRIO MTF 270 x 24/25	158
023077	38.600	Stopend Panel TRIO MTF 270 x 30	218
023076	42.500	Stopend Panel TRIO MTF 270 x 35/36	268

Centre piece with waterstop bar installation for stopend formwork.

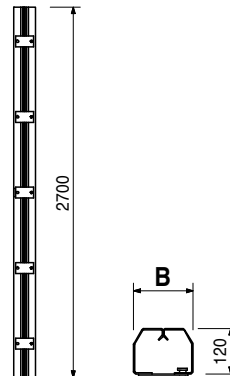

023060	17.200	Stopend Panels TRIO AT	Note Concrete cover approx. 30 or 50 mm.
		Stopend Panel TRIO AT 270 x 3	
105953	19.000	Stopend Panel TRIO AT 270 x 5	

External piece for stopend formwork.

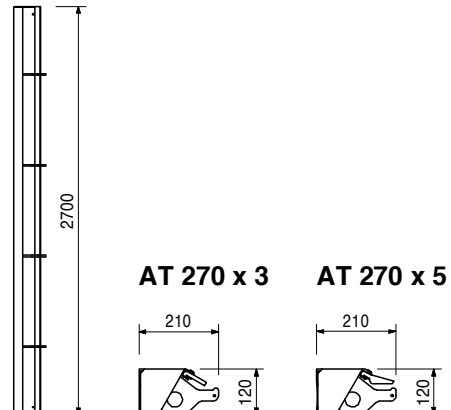

TRIO Panel Formwork

Item no.	Weight kg
022514	162.000

Panel TR 120 x 240
Steel panel with 18 mm plywood.

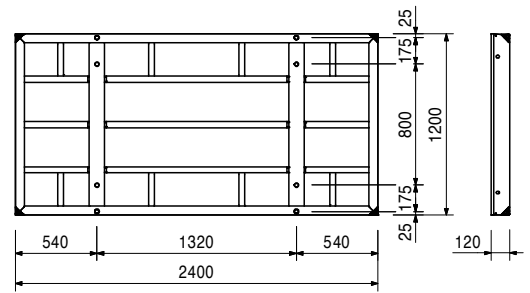
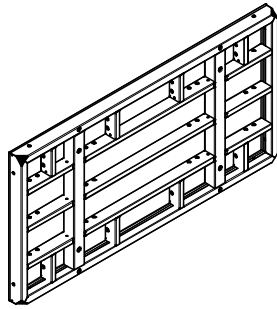

022600	76.100
--------	--------

Panel TR 120 x 120
Steel panel with 18 mm plywood.

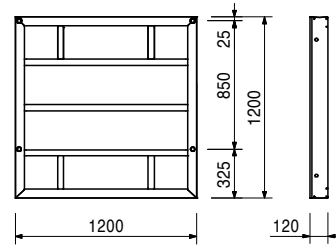
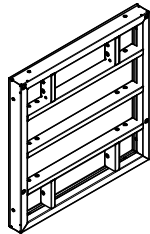

022610	58.300
--------	--------

Panel TR 120 x 90
Steel panel with 18 mm plywood.

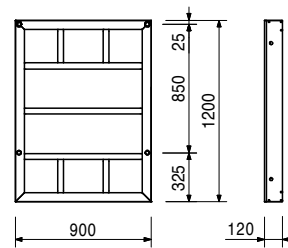
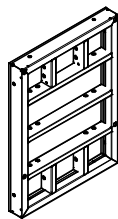

022620	48.600
--------	--------

Panel TR 120 x 72
Steel panel with 18 mm plywood.

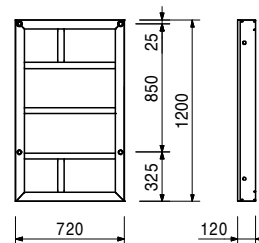
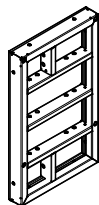

TRIO Panel Formwork



Item no.	Weight kg
022640	43.500

Panel TR 120 x 60
Steel panel with 18 mm plywood.

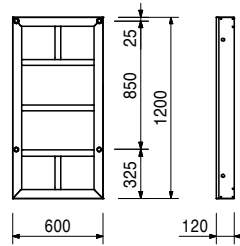
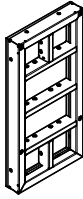

022650	28.400
--------	--------

Panel TR 120 x 30
Steel panel with 18 mm plywood.

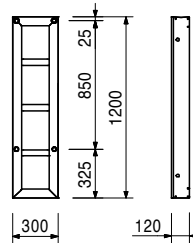

022630	56.300
--------	--------

Multi Panel TRM 120 x 72
Steel panel with 18 mm plywood. For oblique angles, wall connections etc.

Complete with
44 pc. 030300 Plug Ø 20/24 mm

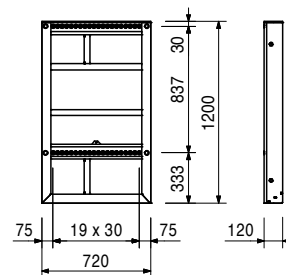
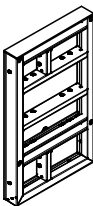

022660	32.900
--------	--------

Inside Corner TE 120-2
Steel panel with 18 mm plywood. For 90° internal corners.

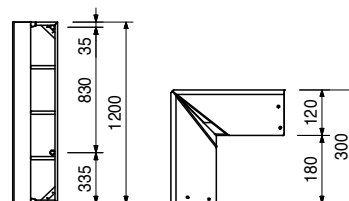
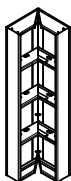

TRIO Panel Formwork

Item no.	Weight kg
023300	43.600

Articulated Corner TGE 120

Steel panel with steel formlining. For oblique angles from 75° upwards, used externally and internally.

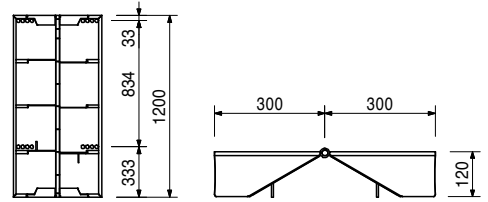
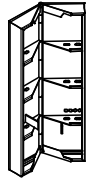

103284	26.400
--------	--------

Internal Corner TEI 120/135°

Steel panel with 18 mm plywood. For 135° internal corners.

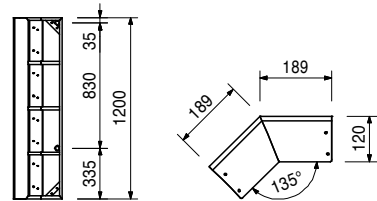

103330	35.900
--------	--------

Outside Corner TEA 120/135°

Steel panel with 18 mm plywood. For 135° external corners.

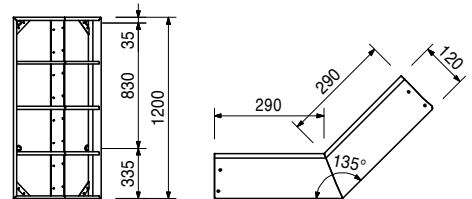
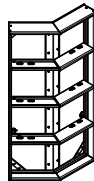

023282	7.610
023292	8.090
023990	4.680

Wall Thickness Comp. WDA 120

Wall Thickness Comp. WDA-2 120 x 5

Wall Thickness Comp. WDA-2 120 x 6

Wall Thickness Comp. WDA 120 x 10, Alu

For adjusting to wall thicknesses.

B

50

60

100

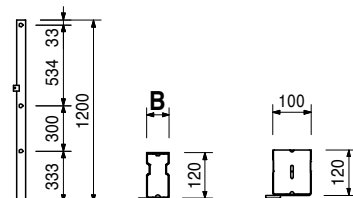

TRIO Panel Formwork



Item no.	Weight kg
023270	24.500

Filler Plate LA 120 x 36

For continuous compensations from 6 to 36 cm.

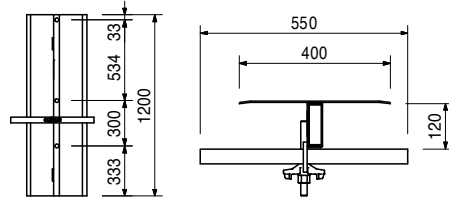
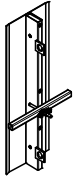

105524	72.600
--------	--------

Shaft Element TSE 120

Panel for moving complete shaft internal formwork.

Complete with

5 pc. 105400 Pin Ø 20 x 140, galv.

5 pc. 018060 Cotter Pin 4/1, galv.

Technical Data

Permissible load-bearing point capacity 2.0 t.

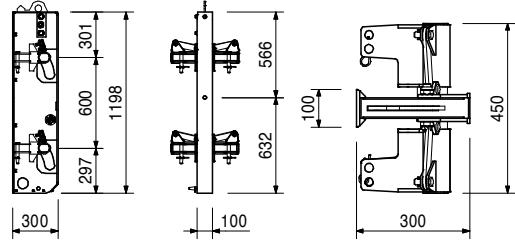

023030	23.600
--------	--------

Stopend Panel TR 120 x 24

Steel panel with 18 mm plywood.

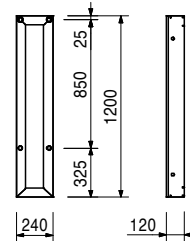

023450	2.060
--------	-------

Filler Support TPA 120

For compensations with 21 mm filler plates.

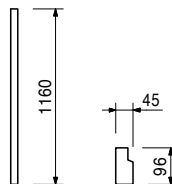

Item no.	Weight kg
101823	3.590

Filler Profile TPP 120, Alu
For compensation with 21 mm filler plates.

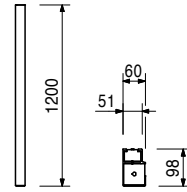

023067	7.790
105978	8.590

Stopend Panels TRIO AT
Stopend Panel TRIO AT 120 x 3
Stopend Panel TRIO AT 120 x 5
External piece for stopend formwork.

Note
Concrete cover approx. 30 mm.

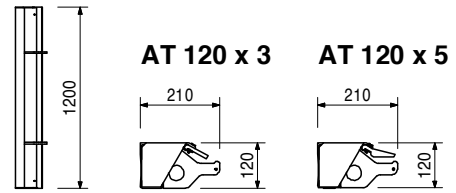

023068	11.800
023069	13.500
023071	16.300
023072	18.500

Stopend Panels TRIO MT w/o waterstop bar
Stopend Panel TRIO MT 120 x 20
Stopend Panel TRIO MT 120 x 24/25
Stopend Panel TRIO MT 120 x 30
Stopend Panel TRIO MT 120 x 35/36
Centre piece without waterstop bar installation for stopend formwork.

B
118
158
218
268

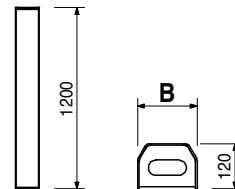

023081	12.800
023080	14.700
023078	16.800
023079	18.600

Stopend Panels TRIO MTF w. waterstop bar
Stopend Panel TRIO MTF 120 x 20
Stopend Panel TRIO MTF 120 x 24/25
Stopend Panel TRIO MTF 120 x 30
Stopend Panel TRIO MTF 120 x 35/36
Centre piece with waterstop bar installation for stopend formwork.

B
118
158
218
268

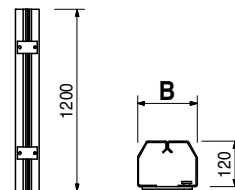

TRIO Panel Formwork

Item no.	Weight kg	
----------	-----------	--

022790 34.500

Panel TR 60 x 90

Steel panel with 18 mm plywood.

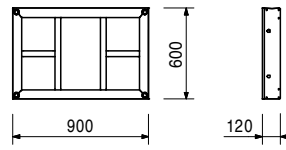
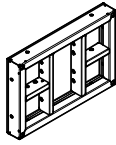

022800 28.600

Panel TR 60 x 72

Steel panel with 18 mm plywood.

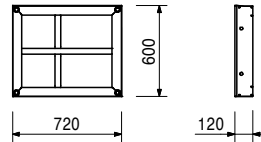
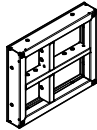

022810 25.700

Panel TR 60 x 60

Steel panel with 18 mm plywood.

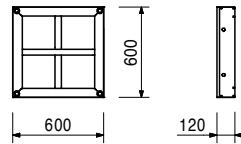
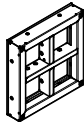

022820 15.600

Panel TR 60 x 30

Steel panel with 18 mm plywood.

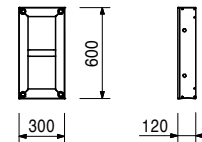

022840 18.000

Inside Corner TE 60-2

Steel panel with 18 mm plywood. For 90° internal corners.

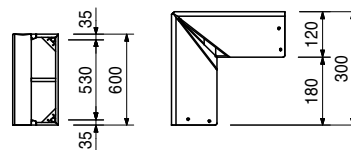

TRIO Panel Formwork

Item no.	Weight kg
023850	70.200

Panel Alu TRA 270 x 90
Aluminium panel with 18 mm plywood.

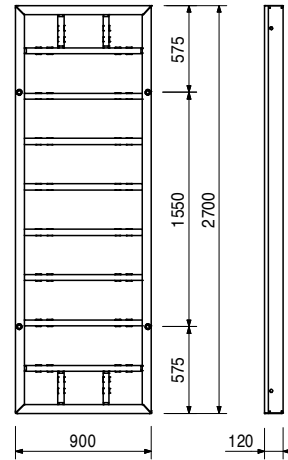
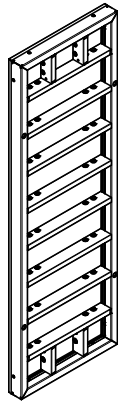

023870	49.300
--------	--------

Panel Alu TRA 270 x 60
Aluminium panel with 18 mm plywood.

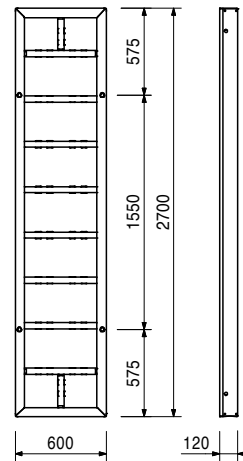
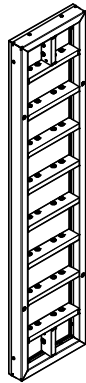

023880	31.400
--------	--------

Panel Alu TRA 270 x 30
Aluminium panel with 18 mm plywood.

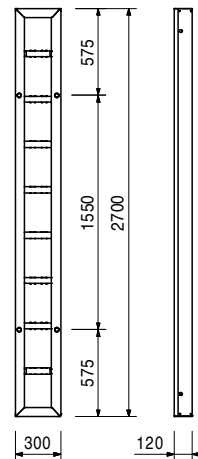

TRIO Panel Formwork



Item no.	Weight kg
023860	60.700

Multi Panel Alu TAM 270 x 72

Alu panel with 18 mm plywood. For oblique angles, wall connections etc.

Complete with

44 pc. 030300 Plug Ø 20/24 mm

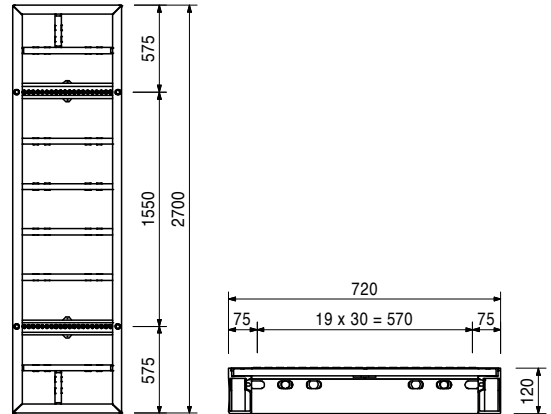
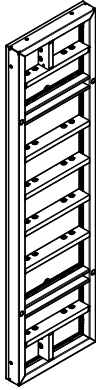

023891	42.200
--------	--------

Corner Alu TAE 270/2

Alu element with 18 mm plywood. For 90° internal corners.

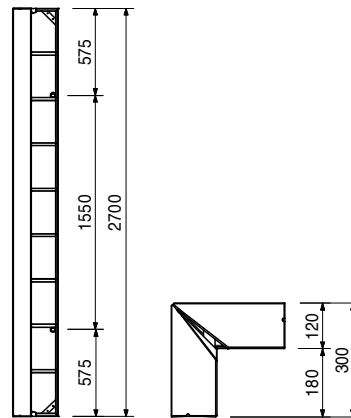
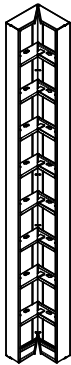

023900	33.600
--------	--------

Panel Alu TRA 90 x 120

Aluminium panel with 18 mm plywood.

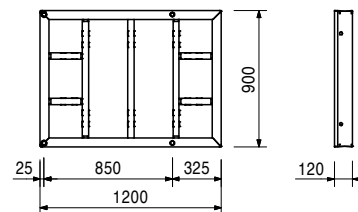
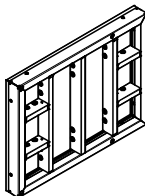

TRIO Panel Formwork



Item no. Weight kg

023950 18.000 **Panel Alu TRA 90 x 60**
Aluminium panel with 18 mm plywood.

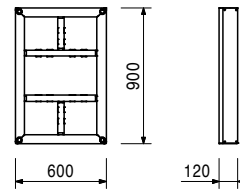
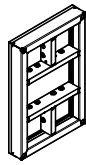

023960 10.700 **Panel Alu TRA 90 x 30**
Aluminium panel with 18 mm plywood.

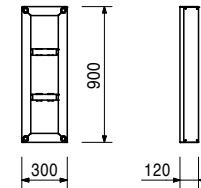

023980 23.500 **Multi Panel Alu TAM 90 x 72**
Alu panel with 18 mm plywood. For oblique angles, wall connections etc.

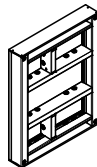

Complete with
44 pc. 030300 Plug Ø 20/24 mm

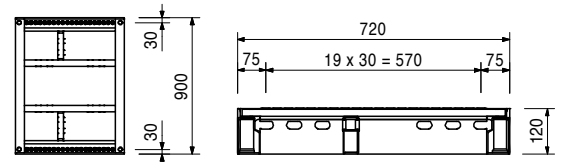

023971 15.200 **Corner Alu TAE 90/2**
Alu element with 18 mm plywood. For 90° internal corners.

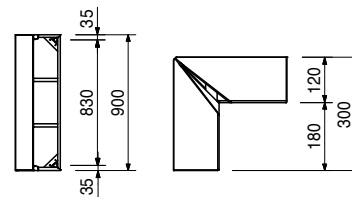
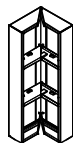

054305	374.000	Panels TRIO Structure TS/4 330
054315	183.000	Panel TRIO Structure TS/4 330 x 240
054325	131.000	Panel TRIO Structure TS/4 330 x 120
054335	112.000	Panel TRIO Structure TS/4 330 x 90
054355	101.000	Panel TRIO Structure TS/4 330 x 72
054365	71.100	Panel TRIO Structure TS/4 330 x 60
054345	128.000	Panel TRIO Structure TSM/4 330 x 72
054375	80.200	Corner TRIO Structure TSE/4 330
054395	10.800	Wall Thickness Comp. WDAS/4 330 x 5, Alu
054405	11.700	Wall Thickness Comp. WDAS/4 330 x 6, Alu

Panel with 21 mm base plate.

Item no.	Weight kg	
		Panels TRIO Structure TS 270
022571	311.000	Panel TRIO Structure TS 270 x 240
022511	152.000	Panel TRIO Structure TS 270 x 120
022521	107.000	Panel TRIO Structure TS 270 x 90
022531	91.600	Panel TRIO Structure TS 270 x 72
022551	82.700	Panel TRIO Structure TS 270 x 60
022561	57.300	Panel TRIO Structure TS 270 x 30
022541	99.800	Panel TRIO Structure TSM 270 x 72
022581	65.600	Corner TRIO Structure TSE 270
023201	88.700	Artic. Corner TRIO Structure TSGE 270
023181	8.840	Wall Thickness Comp. WDAS 270 x 5, Alu
023191	9.560	Wall Thickness Comp. WDAS 270 x 6, Alu Panel with 21 mm base plate.

126740	155.000	Panel TRIO Structure TS 240 x 120 Panel with 21 mm base plate.
--------	---------	--

		Panels TRIO Structure TS 120
022601	72.000	Panel TRIO Structure TS 120 x 120
022611	55.000	Panel TRIO Structure TS 120 x 90
022621	46.000	Panel TRIO Structure TS 120 x 72
022641	41.300	Panel TRIO Structure TS 120 x 60
022651	27.200	Panel TRIO Structure TS 120 x 30
022631	54.900	Panel TRIO Structure TSM 120 x 72
022661	30.900	Corner TRIO Structure TSE 120
023301	41.300	Artic. Corner TRIO Structure TSGE 120
023281	3.970	Wall Thickness Comp. WDAS 120 x 5, Alu
023291	4.320	Wall Thickness Comp. WDAS 120 x 6, Alu Panel with 21 mm base plate.

023500	4.580	Alignment Coupler BFD, galv. For all panel connections for MAXIMO, TRIO and RUNDFLEX. Fillers up to 10 cm.	Technical Data Permissible tension force 20.0 kN.
--------	-------	--	---

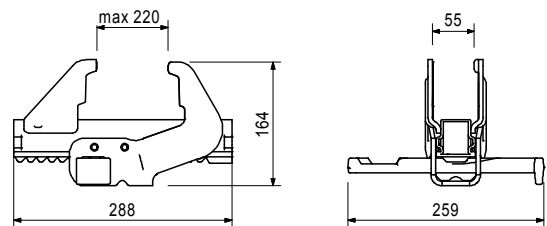
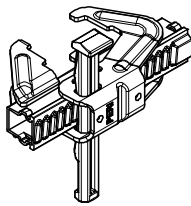

124941	14.100	Waler MAR 85-3 For longitudinal compensation, height extensions, stopend formwork and special applications with MAXIMO. With captive connecting components.	Technical Data Permissible bending moment 3.9 kNm.
--------	--------	---	--

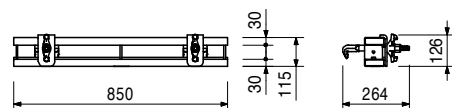
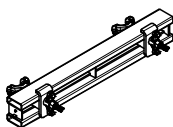

Item no.	Weight kg
127732	11.000

Stopend Waler MX 15 - 40

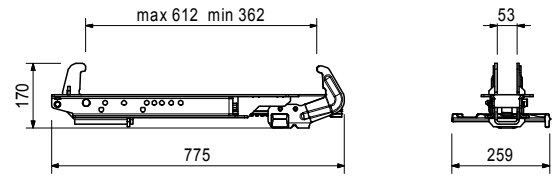
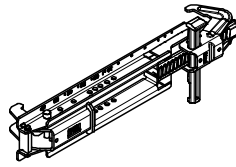

115350	6.310
123842	9.070

Tension and Compression Braces MX Tension and Compression Brace MX 15 – 40 Tension and Compression Brace MX 15 – 100

For use with MAXIMO and TRIO.

Complete with
1 pc. 115331 Bolt Ø 12 x 96, galv.
1 pc. 018060 Cotter Pin 4/1, galv.

Note
Adjustable in 0.5-cm-increments from 15 to 40 cm and in 0.5-cm-increments from 15 to 100 cm.

Technical Data
Permissible tension and compressive force 9 kN.

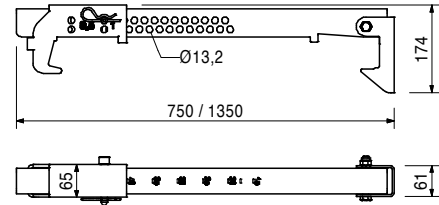
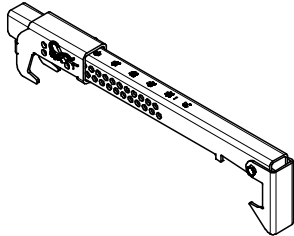

023550	12.300
--------	--------

Compensation Waler TAR 85

For longitudinal compensation, height extensions, stopend formwork and special applications with TRIO and MAXIMO. With captive connecting components.

Technical Data
Permissible bending moment 4.4 kNm.

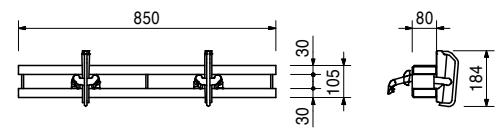
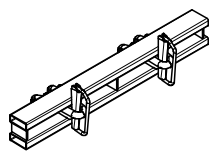

023551	8.520
--------	-------

Waler 85

Corresponds to Compensation Waler TAR 85 but without mounting hooks.

Technical Data
Permissible bending moment 4.4 kNm.

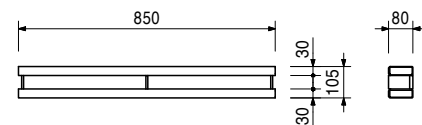
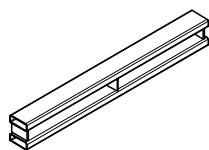

Item no.	Weight kg
128387	8.900

Projection Waler TVR 45/45-2

For connecting on internal corners without using TE Corners particularly for wall offsets.

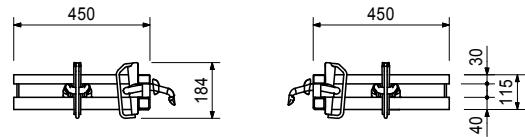
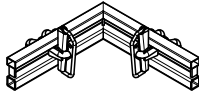

023920	78.400
--------	--------

Universal Waler 245

For anchoring oblique angles especially with thick walls and for special applications.

Complete with

- 6 pc. 024180 Compensation Washer 20, galv.
- 3 pc. 104178 Spacer Unit HFT
- 3 pc. 024910 Bolt ISO 4014 M20 x 100-8.8, galv.
- 3 pc. 781053 Nut ISO 7042 M20-8, galv.

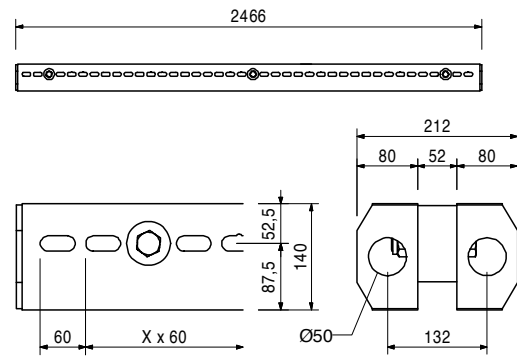
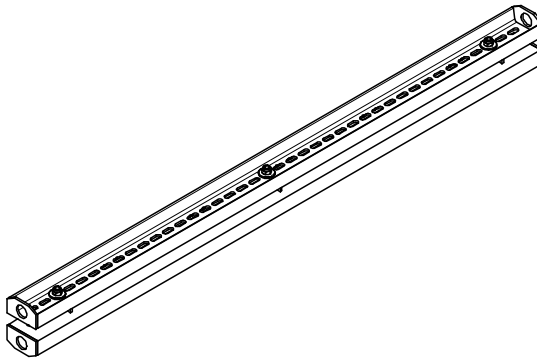

023930	4.100
--------	-------

Waler Stop

For use with the Universal Waler 245.

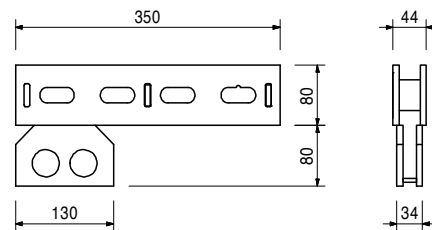
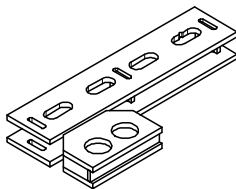

Accessories

024240	0.805
022030	2.170

Wedge KZ, galv.

Tie Yoke, galv.

023640	1.140
--------	-------

Bulkhead Tie TS, galv.

For force application from the stopend formwork in MAXIMO and TRIO panels. DW 15 thread.

Technical Data

Permissible tension force 20.0 kN.

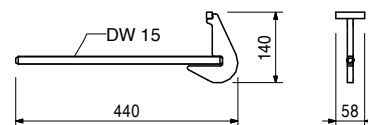
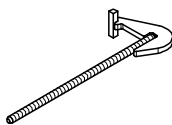

TRIO Panel Formwork

Item no.	Weight kg
023660	3.300

Brace Connector TRIO, galv.

For connecting push-pull props and kicker braces to MAXIMO and TRIO Panels. Mounted on vertical and horizontal struts.

Complete with

1 pc. 027170 Pin \varnothing 16 x 42, galv.
1 pc. 018060 Cotter Pin 4/1, galv.

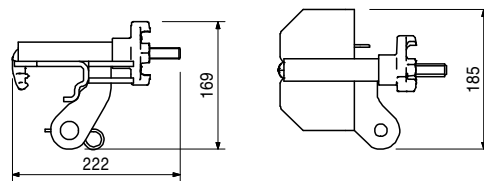
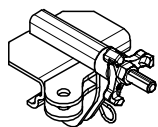

023820	0.375
--------	-------

Hook Tie Head DW 15, galv.

For connecting accessories to MAXIMO and TRIO Panels. DW 15 thread.

Technical Data

Permissible tension force 20.0 kN.

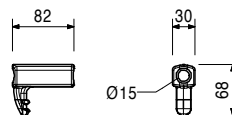

023650	0.769
--------	-------

Hook Tie DW 15, l = 400 mm, galv.

For connecting accessories to MAXIMO and TRIO Panels. DW 15 thread.

Technical Data

Permissible tension force 20.0 kN.

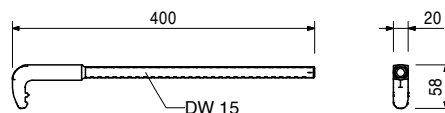
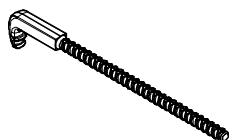

030300	0.002
--------	-------

Plug \varnothing 20/24 mm

For sealing unused tie holes \varnothing 20, \varnothing 22, \varnothing 24 mm.

Note

Delivery unit 250 pieces.

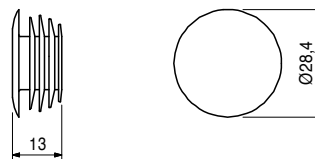

112588	5.520
--------	-------

Stripping Bar TRIO

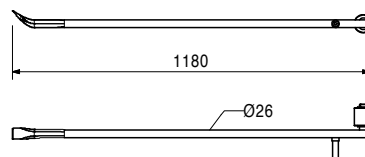
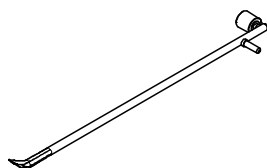

Item no.	Weight kg
054240	1.900

Chamfer Strip, l = 2.70 m

Chamfer strip made of plastic. For TRIO Column Formwork. Edge length 15 x 15 mm.

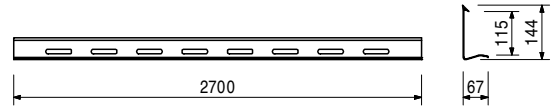
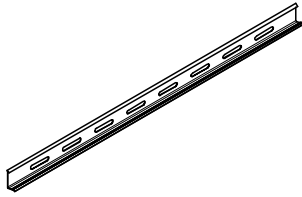

023630	2.080
--------	-------

Top Tie Bracket-2 AH, galv.

For grid-independent anchoring outside of the panel, especially for foundations and height extensions.

Technical Data

Permissible anchor tension force:

Hole 1 = 30 kN

Hole 2 = 15 kN

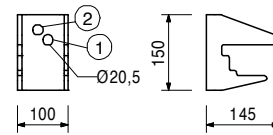
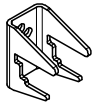

117321	31.000
--------	--------

Lifting Gear Combi MX

For transporting stacks of MAXIMO and TRIO Panels. For attaching Lifting Hook MAXIMO 1.5 t and Stacking Device MAXIMO.

Note

Follow Instructions for Use!

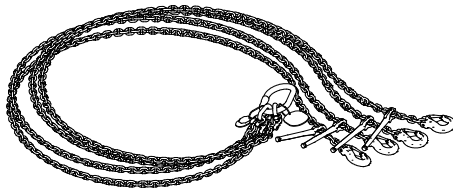

117322	25.000
--------	--------

Lifting Gear MX

For transporting stacks of MAXIMO and TRIO Panels.

Note

Follow Instructions for Use!

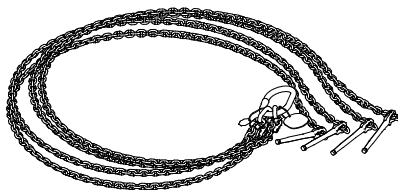

Item no.	Weight kg
115168	7.470

Lifting Hook MAXIMO 1.5 t
For transporting MAXIMO and TRIO Panels.

Note
Follow Instructions for Use!
Technical Data
Permissible load-bearing capacity:
Steel elements 1.5 t
Alu elements 750 kg

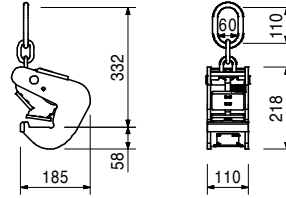

115058	7.450
--------	-------

Stacking Device MAXIMO
For stacking and transportation of 2 – 5 MAXIMO or TRIO Panels of all sizes. Suitable for crane and fork-lift transport.

Note
Follow Instructions for Use!
Technical Data
Permissible load-bearing capacity 650 kg per post, 2.6 t per stack.

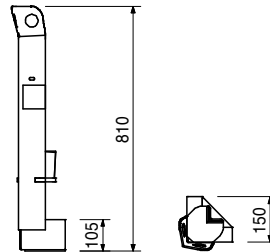
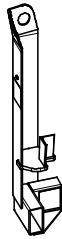

023440	0.312
--------	-------

Lifting Pin TRIO
For easy carrying of TRIO Panels.

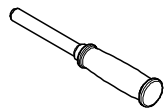
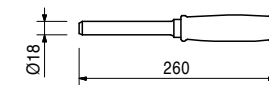

750303	0.014
--------	-------

Stacking Aid TRIO DW 20
Prevents elements sliding and protects the plywood formlining against damage.

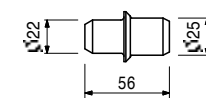

TRIO Panel Formwork



Item no. Weight kg

124554 0.386 **Stacking Device TRIO Corner**

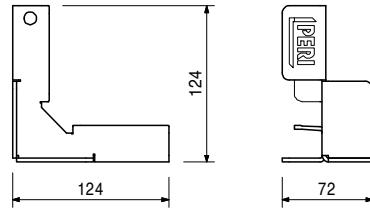
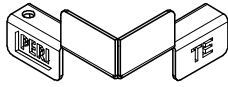

128313 0.395

Stacking Device TRIO LI

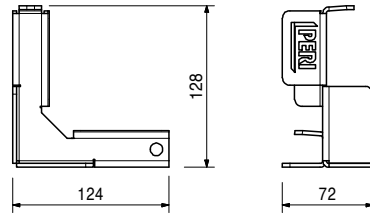
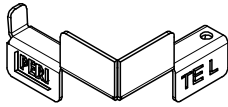

128494 0.395

Stacking Device TRIO RE

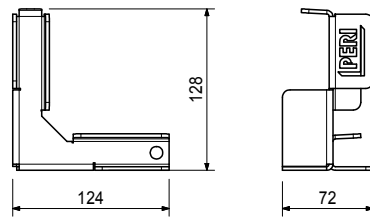
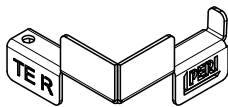

Item no.	Weight kg
023670	12.600
023680	16.700

Scaffold Brackets TRG
Scaffold Bracket TRG 80
Scaffold Bracket TRG 120

For assembly of a working and concreting scaffold with MAXIMO and TRIO. Mounted on horizontal and vertical struts.

Technical Data

Permissible load 150 kg/m²
 with maximum width of influence 1.35 m.

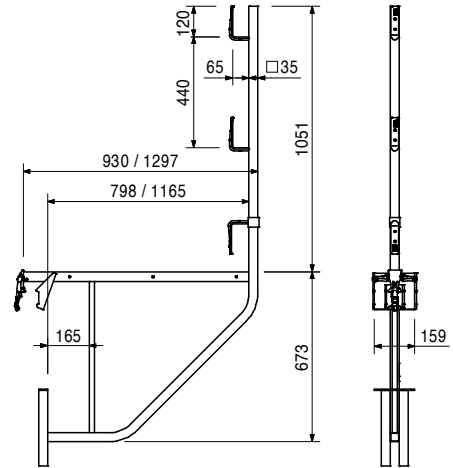
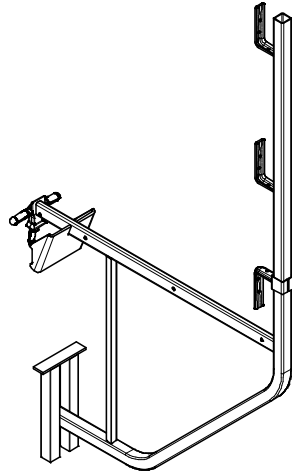

023590	13.000
--------	--------

Scaffold Bracket TRG 100/112

For assembly of a working and concreting scaffold with TRIO and MAXIMO.

Mounted on horizontal and vertical struts. When attaching to the top strut, the scaffolding platform can be cantilevered up to the front edge of the formlining.

Complete with

- 1 pc. 027170 Pin Ø 16 x 42, galv.
- 1 pc. 018060 Cotter Pin 4/1, galv.

Technical Data

Permissible load 150 kg/m²
 with maximum width of influence 1.35 m.

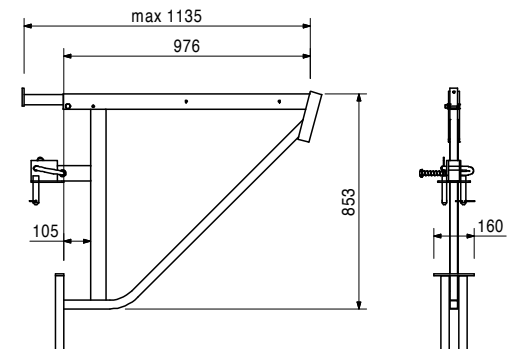
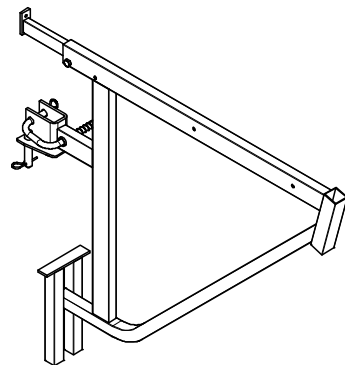

101592	2.810
--------	-------

Guardrail Post Holder TRIO

For assembling of a guardrail to TRIO Panels.

Complete with

- 1 pc. 018060 Cotter Pin 4/1, galv.

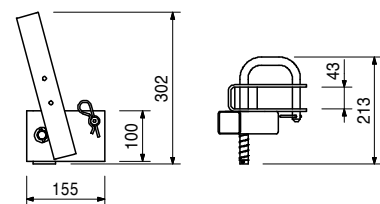
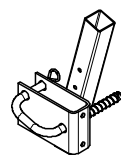

Accessories

116292	4.720
--------	-------

Guardrail Post HSGP-2

Item no.	Weight kg
116292	4.720

Guardrail Post HSGP-2

As guardrail for different systems.

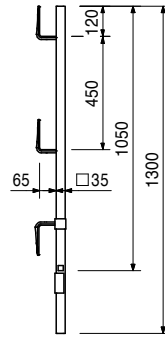

022950	129.000
--------	---------

Concreting Platform TRIO 120 x 270

Working and concreting platform for MAXIMO and TRIO. Attached from above to the panel, self-securing.

Technical Data

Permissible load 150 kg/m².

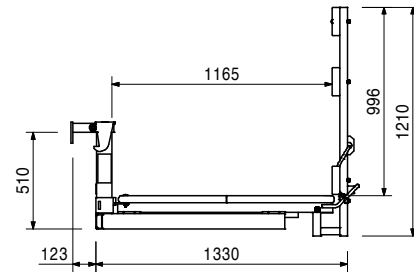
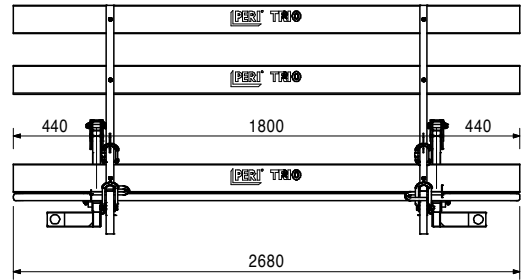
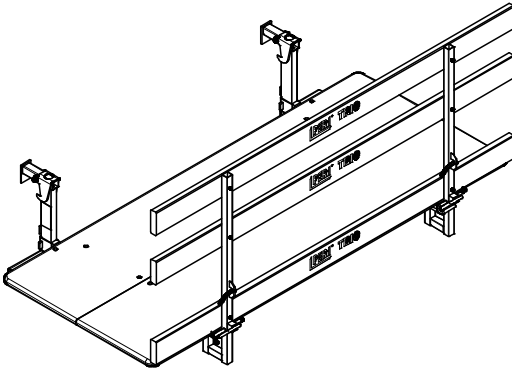

Item no.	Weight kg
027680	49.600

Connector SB-1, 2 - MX/TR/D

For assembly of Brace Frame SB-1, 2 to MAXIMO, TRIO and DOMINO Panels.

Technical Data

Permissible load-bearing point capacity 1.0 t with crane sling angle $\leq 15^\circ$.

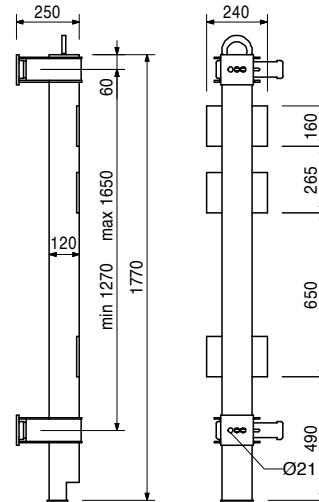
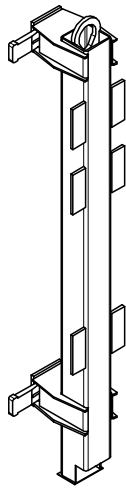

027690	0.368
027590	2.400
113255	0.414
114107	1.190
114417	1.400

Accessories

- Bolt SB-TRIO/DOMINO, galv.**
- Hook Strap for SB-1, 2**
- Bolt SB-MAXIMO, galv.**
- Sleeve SB-MAXIMO, galv.**
- Sleeve SB-MAXIMO WDMX**

025740	9.140
--------	-------

Connector SB-A, B, C - MX/TR/D

For connecting MAXIMO, TRIO and DOMINO Panels with Brace Frames SB-A0, A, B, C.

Note

1 piece per anchor point.

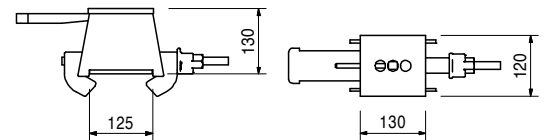
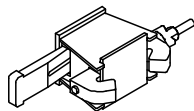

027690	0.368
113255	0.414
114107	1.190
114417	1.400

Accessories

- Bolt SB-TRIO/DOMINO, galv.**
- Bolt SB-MAXIMO, galv.**
- Sleeve SB-MAXIMO, galv.**
- Sleeve SB-MAXIMO WDMX**

027690	0.368
--------	-------

Bolt SB-TRIO/DOMINO, galv.

For panel formwork with 12 cm overall thickness.

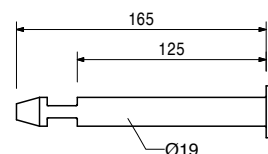
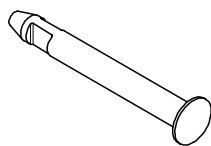

114107	1.190
114417	1.400

Accessories

- Sleeve SB-MAXIMO, galv.**
- Sleeve SB-MAXIMO WDMX**

Item no.	Weight kg
023010	2.330

Foundation Tie Clamp TRIO TLS

For anchoring foundation formwork in combination with the Perforated Foundation Tie.

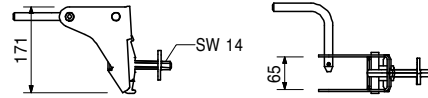
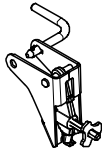

023020	0.676
--------	-------

Perforated Foundation Tie, 25 m

For use with Foundation Tie Clamp TRIO, DOMINO, LIWA and HANDSET.

Technical Data

Permissible tension force 12.9 kN.

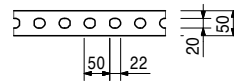
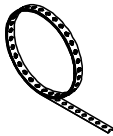

023800	4.840
--------	-------

Foundation Strap TRIO

For connecting TRIO panels with 6 cm wide edge profiles, assembled in a "windmill" configuration.

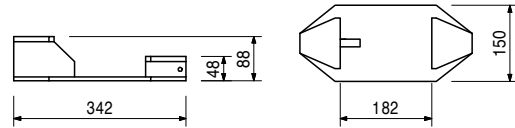
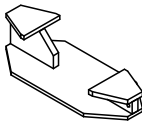

030030	1.440	Tie Rods DW 15
030050	0.000	Tie Rod DW 15, spec. length
030005	0.720	Cutting Cost Tie Rod DW 15, B 15
030010	1.230	Tie Rod DW 15, l = 0.50 m
030480	1.440	Tie Rod DW 15, l = 1.00 m
030490	1.730	Tie Rod DW 15, l = 1.20 m
030170	2.160	Tie Rod DW 15, l = 1.50 m
030020	2.450	Tie Rod DW 15, l = 1.70 m
030180	2.880	Tie Rod DW 15, l = 2.00 m
030710	3.600	Tie Rod DW 15, l = 2.50 m
030720	4.320	Tie Rod DW 15, l = 3.00 m
030730	5.040	Tie Rod DW 15, l = 3.50 m
030160	8.640	Tie Rod DW 15, l = 6.00 m

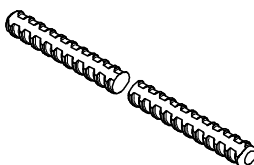

Note

Non-weldable! Take official Approval into consideration!

Technical Data

Permissible tension force 90 kN.

Item no.	Weight kg
030990	0.786

Wingnut DW 20, galv.
For anchoring with Tie Rod DW 20 and B 20.

Technical Data
Permissible load 150 kN.

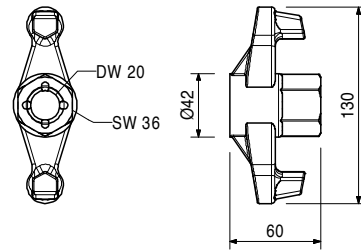

030100	0.439
--------	-------

Wingnut DW 15, galv.
For anchoring with Tie Rod DW 15 and B 15.

Technical Data
Permissible load 90 kN.

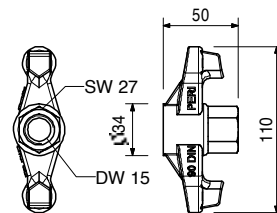

030370	1.660
--------	-------

Wingnut Pivot Plate DW 15, galv.
For anchoring with Tie Rod DW 15 and B 15. With pivoting captive nut. Maximum angle of tilting 8°.

Note
Wrench size SW 27.
Technical Data
Permissible load 90 kN.

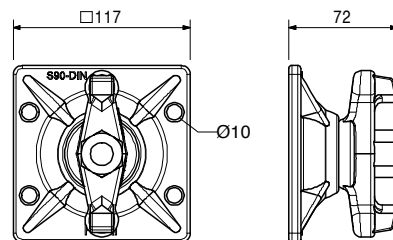
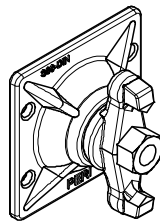

065033	0.010
--------	-------

Cone DR 22
Plastic. Suitable for Spacer Tube DR 22.

Note
Delivery unit 500 pieces.

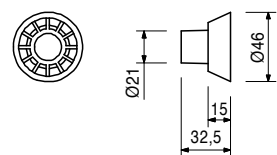

Item no.	Weight kg		L
065027	0.359	Spacer Tubes rough DR 22	2000
065031	0.050	Spacer Tube rough DR 22, l = 2.00 m	270
065030	0.039	Spacer Tube rough DR 22, l = 0.21 m	210

Plastic Spacer Tube for DW 15, B 15.

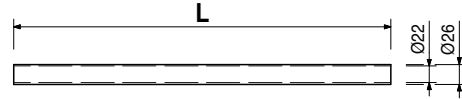
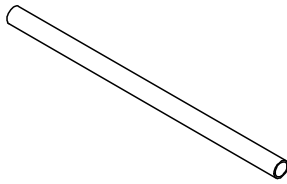

030700	2.560	Tie Rods DW 20	Note Non-weldable! Take official Approval into consideration! Technical Data Permissible tension force 150 kN.
030800	0.000	Tie Rod DW 20, spec. length	
030640	1.280	Cutting Cost Tie Rod DW 20/B 20	
030641	2.560	Tie Rod DW 20, l = 0.50 m	
030680	15.400	Tie Rod DW 20, l = 6.00 m	

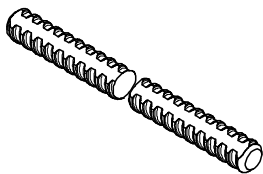

031636	0.063	DK Cone DW 15/55	Note Delivery unit 50 pieces.
For waterproof, fire-resistant and soundproof anchor points with Tie Rod DW 15. Used with Spacer Tube rough 22.			

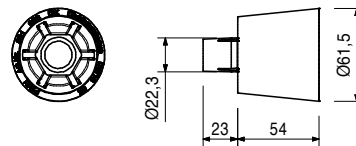
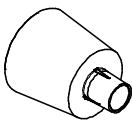

031637	0.055	DK Cone DW 20/55	Note Delivery unit 50 pieces.
For waterproof, fire-resistant and soundproof anchor points with Tie Rod DW 20. Use with Spacer Tube rough 28.			

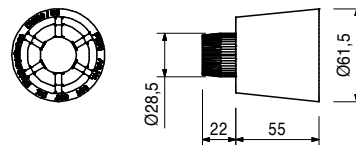
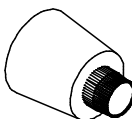

Item no.	Weight kg
030830	2.180

Counterplate DW 20, 120 x 120 x 20
For anchoring with Tie Rod DW 20 and B 20.

Technical Data
Permissible load 150 kN.

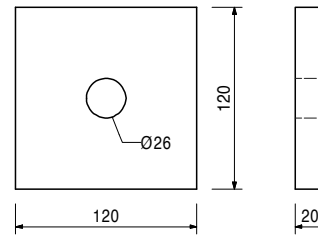
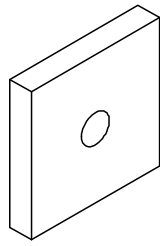

031070	1.260
--------	-------

Tie Rod Wrench 15, galv.
For easy handling of Tie Rod DW 15.

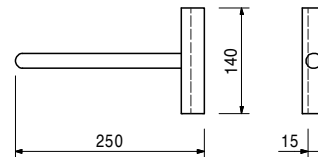
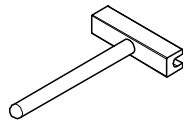

022030	2.170
--------	-------

Tie Yoke, galv.
For anchoring with Tie Rod DW 15 and B 15.

Technical Data
Permissible load 90 kN.

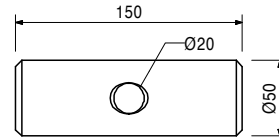
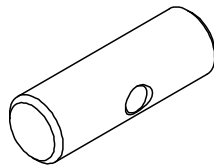

030130	0.318
--------	-------

Cam Nut DW 15, galv.
For anchoring with Tie Rod DW 15 and B 15.

Technical Data
Permissible load 90 kN.

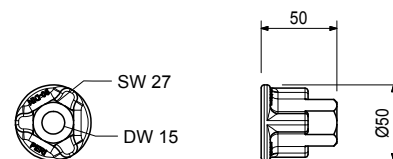
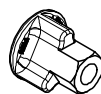

Item no.	Weight kg
127273	192.000

Concreting Platform MX 100 x 240

Working and concreting platform for MAXIMO and TRIO. Attached from above to the panel, selfsecuring.

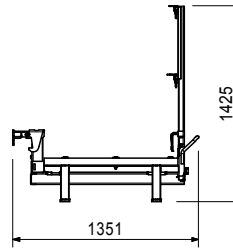
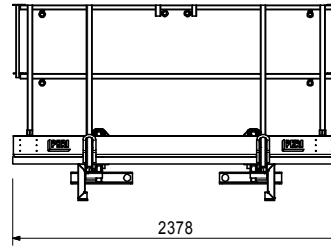
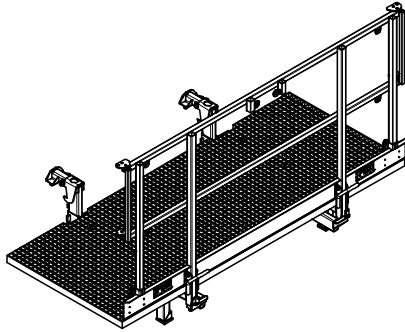

115945	10.700
115946	10.700

End Guardrails MXP

End Guardrail MXP left

End Guardrail MXP right

For MAXIMO Platforms MXP.
Drawing shows End Guardrail MXP left.

Complete with

2 pc. 722802 Eye Bolt M10 DIN 580, galv.

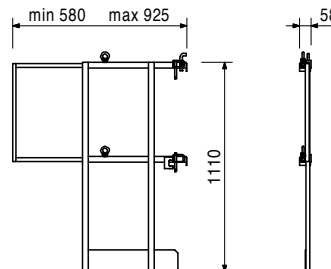
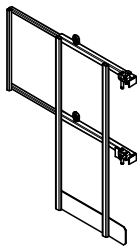

127885	71.600
--------	--------

Concreting Platform Hatch MX 100 x 100

Working and concreting platform for MAXIMO and TRIO. Attached from above to the panel, selfsecuring.

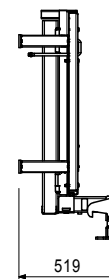
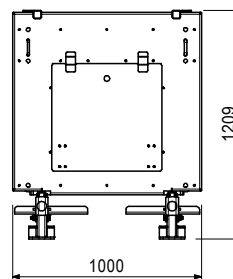
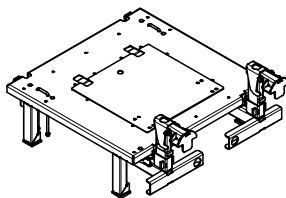

Item no.	Weight kg
126360	4.920

Guardrail Post MXK

As guardrail for MAXIMO and TRIO.

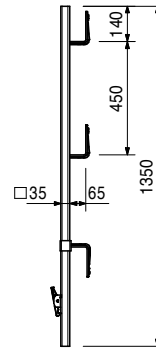

126381	7.140
126376	9.260
126371	17.700

Side Mesh Barriers PMB

- Side Mesh Barrier PMB 90
- Side Mesh Barrier PMB 120
- Side Mesh Barrier PMB 240

L

- 900
- 1180
- 2400

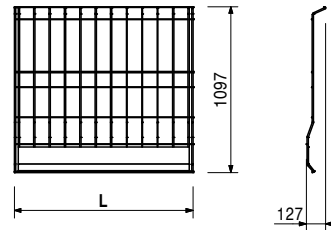
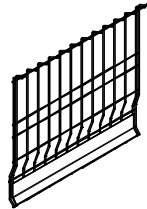

126356	10.200
--------	--------

Scaffold Bracket MXK

For assembly of a working and concreting scaffold with MAXIMO and TRIO.

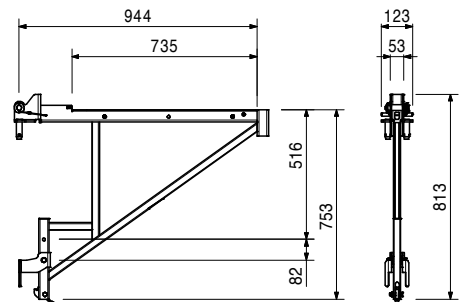
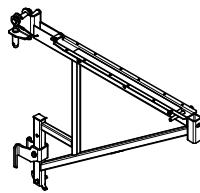

126360	4.920
--------	-------

Accessories

Guardrail Post MXK

Item no.	Weight kg
126540	14.600

Scaffold Bracket MXK-RS

For assembly of a working and concreting scaffold with MAXIMO and TRIO.

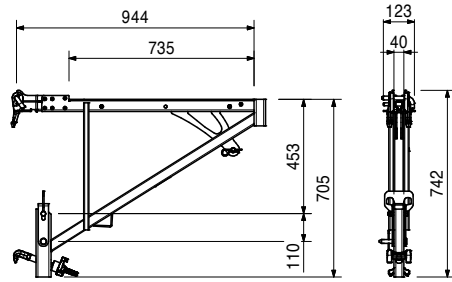
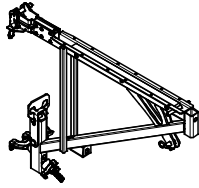

Accessories

126360	4.920
--------	-------

Guardrail Post MXK

117466	10.600
--------	--------

Push-Pull Prop RS 210, galv.

Extension length $l = 1.30 - 2.10$ m.
For aligning PERI Formwork Systems and precast concrete elements.

Note

Permissible load see PERI Design Tables.

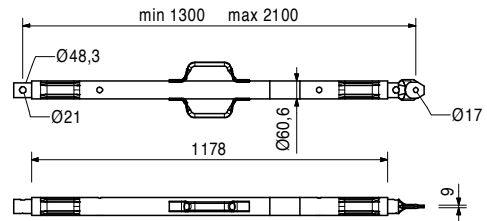
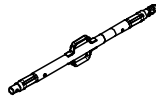

118238	12.100
--------	--------

Push-Pull Prop RS 260, galv.

Extension length $l = 2.30 - 2.60$ m.
For aligning PERI Formwork Systems and precast concrete elements.

Note

Permissible load see PERI Design Tables.

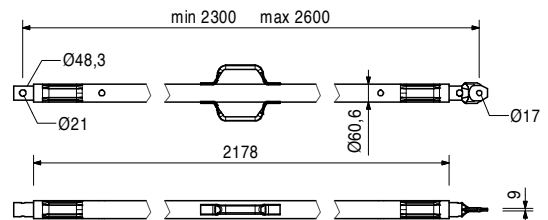
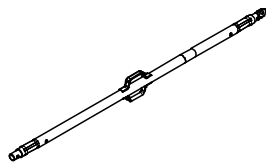

TRIO Panel Formwork



Item no.	Weight kg
117467	15.500

Push-Pull Prop RS 300, galv.

Extension length $l = 1.90 - 3.00$ m.
For aligning PERI Formwork Systems and precast concrete elements.

Note

Permissible load see PERI Design Tables.

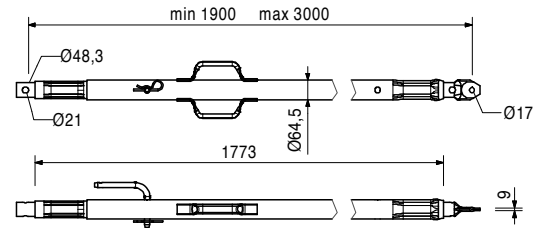
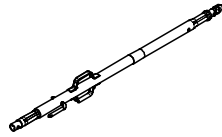

117468	23.000
--------	--------

Push-Pull Prop RS 450, galv.

Extension length $l = 2.80 - 4.50$ m.
For aligning PERI Formwork Systems and precast concrete elements.

Note

Permissible load see PERI Design Tables.

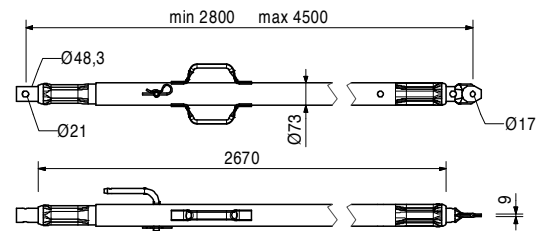
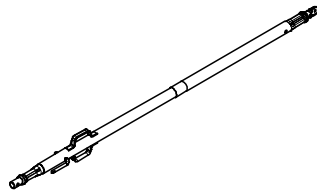

117469	39.900
--------	--------

Push-Pull Prop RS 650, galv.

Extension length $l = 4.30 - 6.50$ m.
For aligning PERI formwork systems and precast concrete elements.

Note

Permissible load see PERI Design Tables.

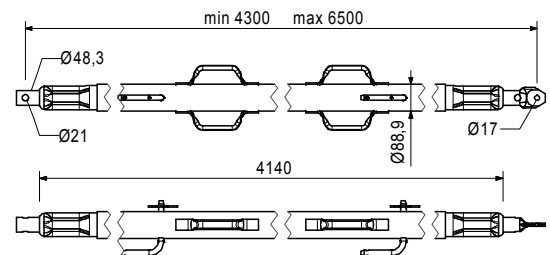
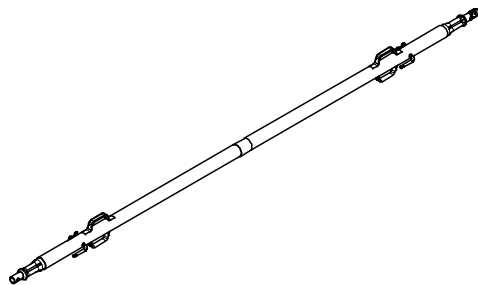

028990	115.000
--------	---------

Push-Pull Prop RS 1000, galv.

Extension length $l = 6.40 - 10.00$ m.
For aligning PERI formwork systems.

Note

Permissible load see PERI Design Tables.

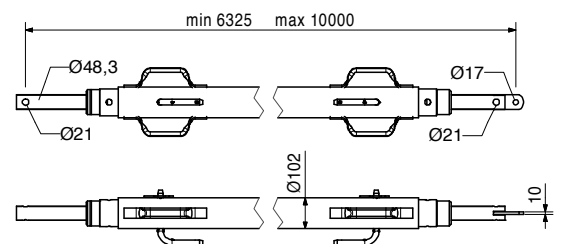
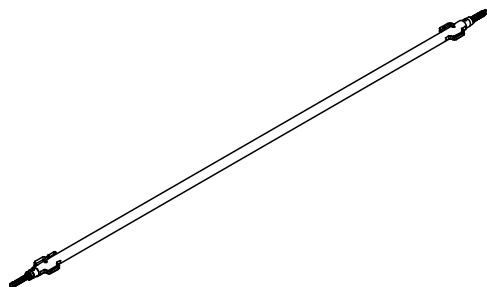

Item no.	Weight kg
103800	271.000

Push-Pull Prop RS 1400, galv.

Extension length $l = 6.40 - 14.00$ m.
For aligning PERI formwork systems.

Note

Permissible load see PERI Design Tables.
Chain can be operated from bottom.

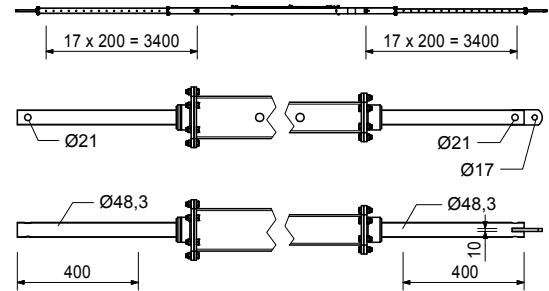
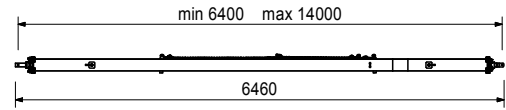
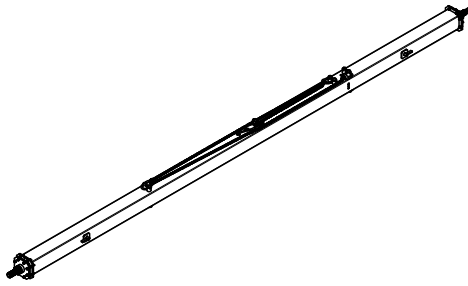

126666	3.070
--------	-------

Base Plate-3 for RS 210 - 1400

For assembly of Push-Pull Props RS 210, 260, 300, 450, 650, 1000 and 1400.

Complete with

- 2 pc. 105400 Pin $\varnothing 20 \times 140$, galv.
- 2 pc. 018060 Cotter Pin 4/1, galv.
- 1 pc. 113063 Bolt ISO 4014 M12 x 80-8.8, galv.
- 1 pc. 113064 Hex Nut ISO7042-M12-8-G, galv.

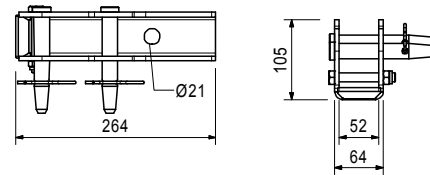
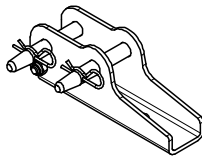

Accessories

124777	0.210
--------	-------

Anchor Bolt PERI 14/20 x 130

102018	4.880
--------	-------

Base Plate-2 for RS 1000/1400, galv.

For assembly of Push-Pull Props RS 210, 260, 300, 450, 650, 1000, 1400 and Heavy Duty Spindles.

Complete with

- 2 pc. 105400 Pin $\varnothing 20 \times 140$, galv.
- 2 pc. 018060 Cotter Pin 4/1, galv.

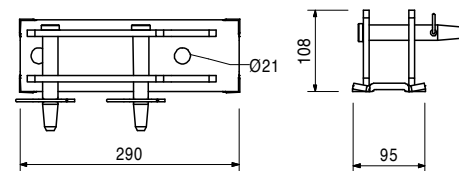
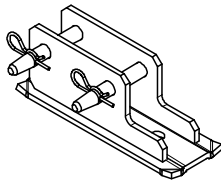

Item no.	Weight kg
117343	3.250

Base Plate-2 for RS 210 - 1400, galv.
 For assembly of Push-Pull Props RS 210, 260, 300, 450, 650, 1000 and 1400.

Complete with
 2 pc. 105400 Pin \varnothing 20 x 140, galv.
 2 pc. 018060 Cotter Pin 4/1, galv.

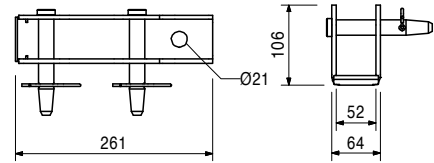
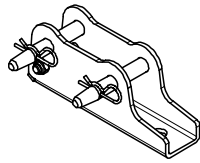

Accessories

124777	0.210
--------	-------

Anchor Bolt PERI 14/20 x 130

028010	17.900
--------	--------

Push-Pull Prop RSS I
 Extension length $l = 2.05 - 2.94$ m.
 For aligning PERI Formwork Systems.

Note
 Permissible load see PERI Design Tables.

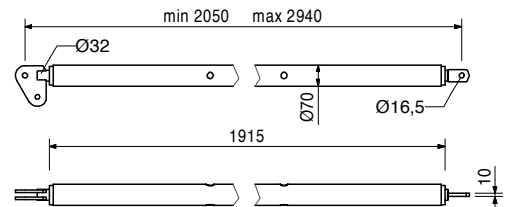
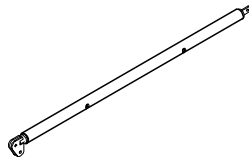

Accessories

113397	1.600
--------	-------

Spindle Handle RSS / AV

113397	1.600
--------	-------

Spindle Handle RSS / AV
 Spindle handle for screwing on Push-Pull-Props RSS I, RSS II and Kickers AV 210 and AV RSS III.

Complete with
 2 pc. 722342 Screw ISO 4017 M8 x 25-8.8, galv.
 2 pc. 711071 Nut ISO 7042 M8-8, galv.

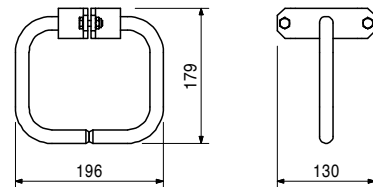
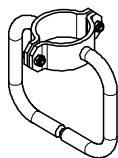

028020	22.000
--------	--------

Push-Pull Prop RSS II
 Extension length $l = 2.91 - 3.80$ m.
 For aligning PERI Formwork Systems.

Note
 Permissible load see PERI Design Tables.

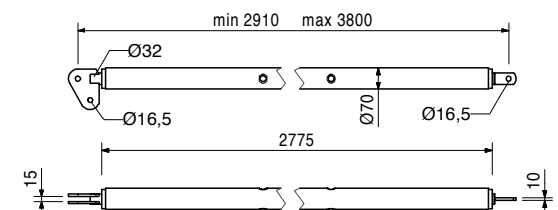
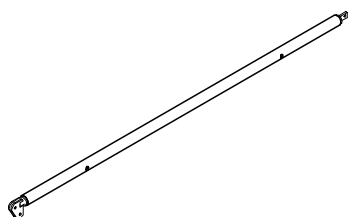

Accessories

113397	1.600
--------	-------

Spindle Handle RSS / AV

Item no.	Weight kg
028030	38.400

Push-Pull Prop RSS III

Extension length l = 4.60 – 6.00 m.
For aligning PERI formwork systems.

Note

Permissible load see PERI Design Tables.

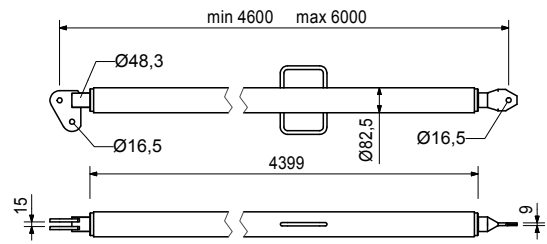
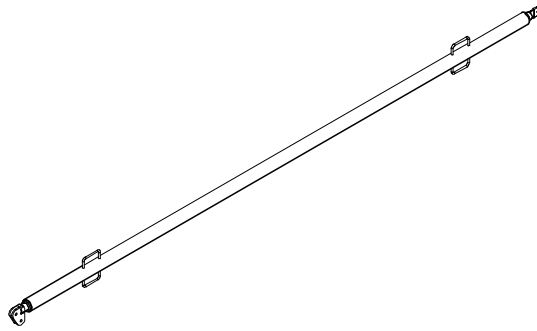

106000	1.820
--------	-------

Base Plate-2 for RSS, galv.

For assembly of Push-Pull Props RSS.

Complete with

1 pc. 027170 Pin Ø 16 x 42, galv.
1 pc. 018060 Cotter Pin 4/1, galv.

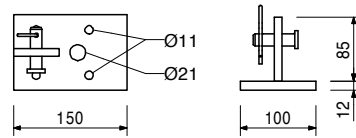
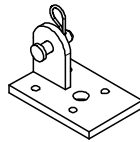

124777	0.210
--------	-------

Accessories

Anchor Bolt PERI 14/20 x 130

057087	3.510
057088	4.200

Kickers AV

Kicker AV 82

Kicker AV 111

For aligning PERI Formwork Systems.

min. L	max. L
500	820
790	1110

Complete with

1 pc. 027170 Pin Ø 16 x 42, galv.
1 pc. 018060 Cotter Pin 4/1, galv.

Note

Permissible load see PERI Design Tables.

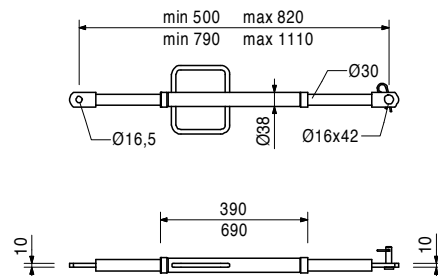
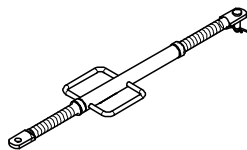

Item no.	Weight kg
028110	4.850

Kicker AV 140

Extension length $l = 1.08 - 1.40$ m.
For aligning PERI Formwork Systems.

Complete with

1 pc. 027170 Pin $\varnothing 16 \times 42$, galv.
1 pc. 018060 Cotter Pin 4/1, galv.

Note

Permissible load see PERI Design Tables.

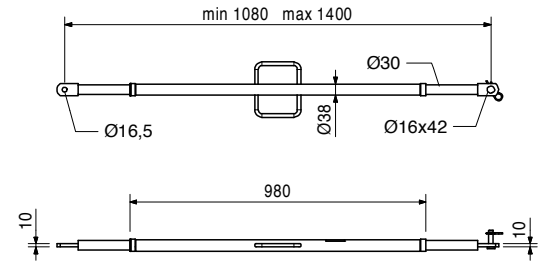
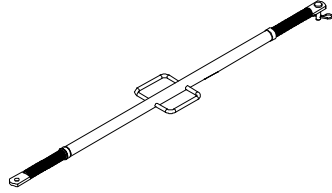

108135	12.900
--------	--------

Kicker AV 210

Extension length $l = 1.28 - 2.10$ m.
For aligning PERI Formwork Systems.

Complete with

1 pc. 027170 Pin $\varnothing 16 \times 42$, galv.
1 pc. 018060 Cotter Pin 4/1, galv.

Note

Permissible load see PERI Design Tables.

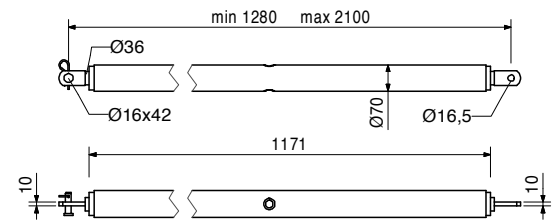
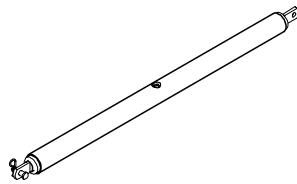

Accessories

113397	1.600
--------	-------

Spindle Handle RSS / AV

028120	17.000
--------	--------

Kicker AV RSS III

Extension length $l = 2.03 - 2.92$ m.
For aligning PERI formwork systems.

Complete with

1 pc. 027170 Pin $\varnothing 16 \times 42$, galv.
1 pc. 018060 Cotter Pin 4/1, galv.

Note

Permissible load see PERI Design Tables.

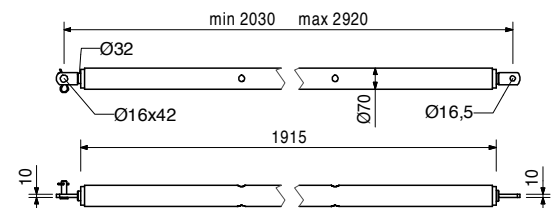
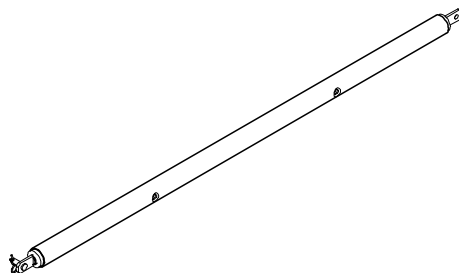

Accessories

113397	1.600
--------	-------

Spindle Handle RSS / AV

Item no.	Weight kg
022016	1.290

Brace Connector HDR

For connecting push-pull props and kicker braces to components Ø 48 mm.

Complete with

1 pc. 027170 Pin Ø 16 x 42, galv.
1 pc. 018060 Cotter Pin 4/1, galv.

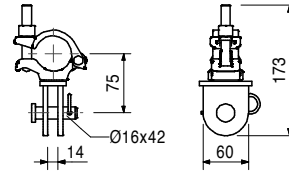
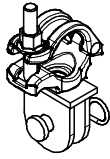

124777	0.210
--------	-------

Anchor Bolt PERI 14/20 x 130

For temporary fixation to reinforced concrete structures.

Note

See PERI data sheet!
Drilling Ø 14 mm.

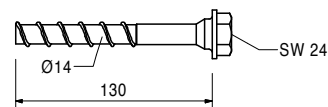
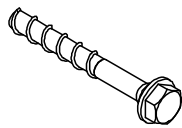

PERI International

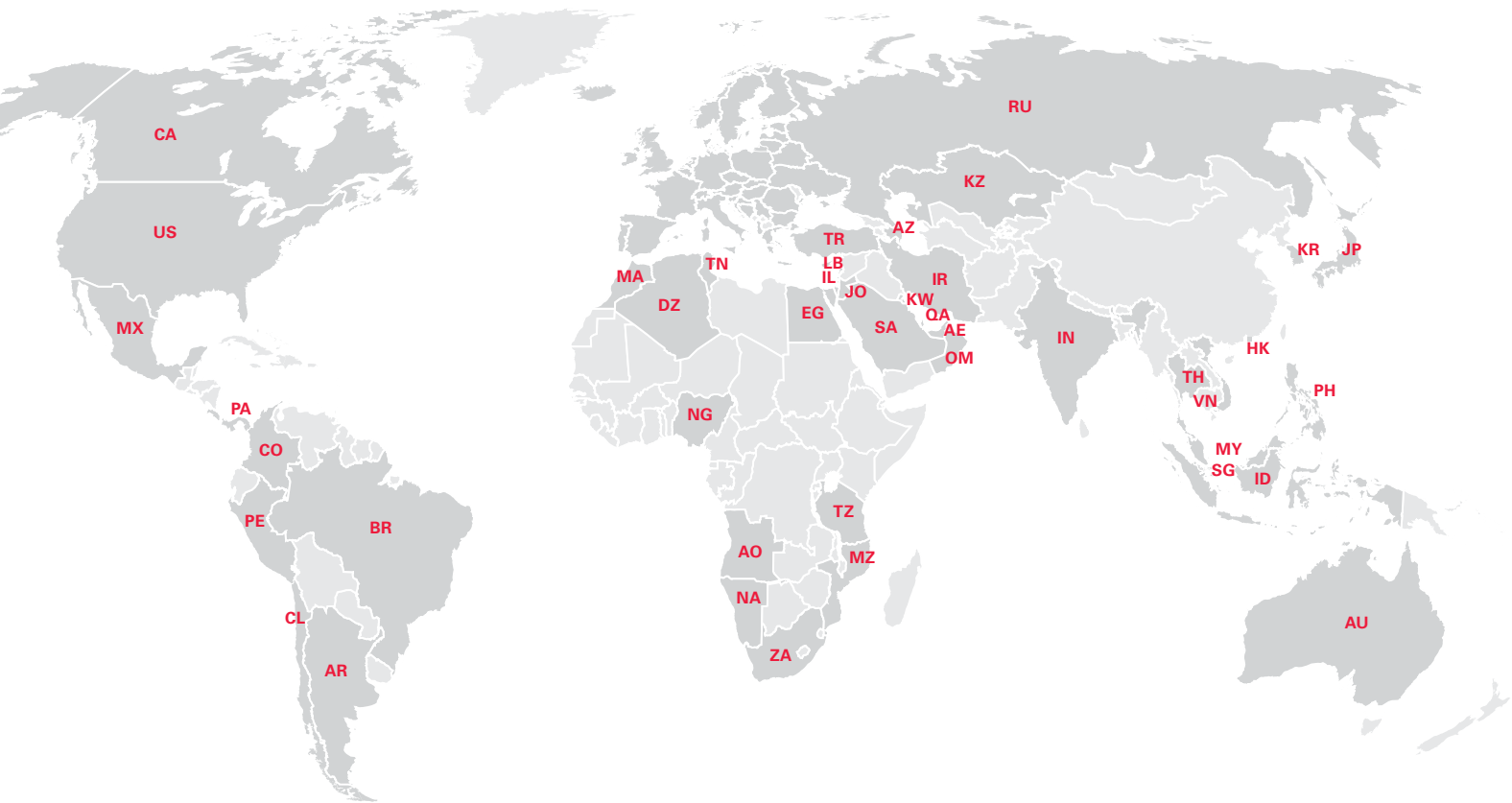

North America

- CA** Canada
PERI Formwork Systems, Inc.
www.peri.ca
- MX** Mexico
PERI Cimbras y Andamios, S.A. de C.V.
www.peri.com.mx
- PA** Panama
PERI Panama Inc.
www.peri.com.pa
- US** USA
PERI Formwork Systems, Inc.
www.peri-usa.com

South America

- AR** Argentina
PERI S.A.
www.peri.com.ar
- BR** Brazil
PERI Formas e Escoramentos Ltda.
www.peribrasil.com.br
- CL** Chile
PERI Chile Ltda.
www.peri.cl
- CO** Colombia
PERI S.A.S.
www.peri.com.co
- PE** Peru
PERI Peruana S.A.C.
www.peri.com.pe

Africa

- AO** Angola
Pericofragens, Lda.
www.peri.pt
- DZ** Algeria
S.A.R.L. PERI
www.peri.dz
- EG** Egypt
Egypt Branch Office
www.peri.com.eg
- MA** Morocco
PERI S.A.
www.peri.ma
- MZ** Mozambique
PERI (Pty.) Ltd.
www.peri.co.mz
- NA** Namibia
PERI (Pty.) Ltd.
www.peri.na
- NG** Nigeria
PERI Nigeria Ltd.
www.peri.ng
- TN** Tunisia
PERI S.A.U.
www.peri.es
- TZ** Tanzania
PERI Formwork and Scaffolding Ltd
www.peri.co.tz
- ZA** South Africa
PERI Formwork Scaffolding (Pty) Ltd
www.peri.co.za

Asia

- AE** United Arab Emirates
PERI (L.L.C.)
www.peri.ae
- AZ** Azerbaijan
PERI Representative Office
www.peri.com.tr
- HK** Hong Kong
PERI (Hong Kong) Limited
www.perihk.com
- ID** Indonesia
PT Beton Perkasa Wijaksana
www.betonperkasa.com
- IL** Israel
PERI F.E. Ltd.
www.peri.co.il
- IN** India
PERI (India) Pvt Ltd
www.peri.in
- IR** Iran
PERI Pars. Ltd.
www.peri.ir
- JO** Jordan
PERI GmbH – Jordan
www.peri.com
- JP** Japan
PERI Japan K.K.
www.peri.co.jp
- KR** Korea
PERI (Korea) Ltd.
www.perikorea.com
- KW** Kuwait
PERI Kuwait W.L.L.
www.peri.com.kw
- KZ** Kazakhstan
TOO PERI Kazakhstan
www.peri.kz
- LB** Lebanon
PERI Lebanon Sarl
lebanon@peri.de
- MY** Malaysia
PERI Formwork Malaysia Sdn. Bhd.
www.perimalaysia.com
- OM** Oman
PERI (L.L.C.)
www.peri.ae
- PH** Philippines
PERI-Asia Philippines, INC.
www.peri.com.ph
- QA** Qatar
PERI Qatar LLC
www.peri.qa
- SA** Saudi Arabia
PERI Saudi Arabia Ltd.
www.peri.com.sa
- SG** Singapore
PERI Asia Pte Ltd
www.periasia.com
- TH** Thailand
Peri (Thailand) Co., Ltd.
www.peri.co.th
- TR** Turkey
PERI Kalıp ve İskeleleri
www.peri.com.tr
- VN** Vietnam
PERI ASIA PTE LTD
www.peri.com.vn



PERI

**PERI GmbH
Formwork Scaffolding Engineering**

Rudolf-Diesel-Strasse 19
89264 Weissenhorn
Germany
Tel. +49 (0)7309.950-0
Fax +49 (0)7309.951-0
info@peri.com
www.peri.com

Oceania

AU Australia
PERI Australia Pty. Ltd.
www.periaus.com.au

DK Denmark
PERI Danmark A/S
www.peri.dk

IT Italy
PERI S.r.l.
www.peri.it

SE Sweden
PERI Sverige AB
www.peri.se

Europe

EE Estonia
PERI AS
www.peri.ee

LT Lithuania
PERI UAB
www.peri.lt

SI Slovenia
PERI oplate i skele d.o.o
www.peri.com.hr

AL Albania
PERI Kalıp ve İskeleleri
www.peri.com.tr

ES Spain
PERI S.A.U.
www.peri.es

LU Luxembourg
N.V. PERI S.A.
www.peri.lu

SK Slovakia
PERI spol. s. r.o.
www.peri.sk

AT Austria
PERI Ges.mbh
www.peri.at

FI Finland
PERI Suomi Ltd. Oy
www.perisuomi.fi

LV Latvia
PERI SIA
www.peri-latvija.lv

UA Ukraine
TOW PERI
www.peri.ua

BA Bosnia and Herzegovina
PERI oplate i skele d.o.o
www.peri.com.hr

FR France
PERI S.A.S.
www.peri.fr

NL Netherlands
PERI b.v.
www.peri.nl

BE Belgium
PERI N.V.
www.peri.be

GB United Kingdom
PERI Ltd.
www.peri.ltd.uk

NO Norway
PERI Norge AS
www.peri.no

BG Bulgaria
PERI Bulgaria EOOD
www.peri.bg

GR Greece
PERI Hellas Ltd.
www.perihellas.gr

PL Poland
PERI Polska Sp. z o.o.
www.peri.com.pl

BY Belorussia
IOOO PERI
www.peri.by

HR Croatia
PERI oplate i skele d.o.o.
www.peri.com.hr

PT Portugal
Pericofragens Lda.
www.peri.pt

CH Switzerland
PERI AG
www.peri.ch

HU Hungary
PERI Kft.
www.peri.hu

RO Romania
PERI România SRL
www.peri.ro

CZ Czech Republic
PERI spol. s r.o.
www.peri.cz

IR Ireland
Siteserv Access & Formwork
www.siteservaccess.ie

RS Serbia
PERI oplate d.o.o.
www.peri.rs

DE Germany
PERI GmbH
www.peri.de

IS Iceland
Armar ehf.
www.armor.is

RU Russia
OOO PERI
www.peri.ru

**The optimal System
for every Project and
every Requirement**



Wall Formwork



Column Formwork



Slab Formwork



Climbing Systems



Bridge Formwork



Tunnel Formwork



Shoring Systems



Construction Scaffold



Facade Scaffold



Industrial Scaffold



Access



Protection Scaffold



Safety Systems



System-Independent Accessories



Services



PERI GmbH
Formwork Scaffolding Engineering
 Rudolf-Diesel-Strasse 19
 89264 Weissenhorn
 Germany
 Tel. +49 (0)7309.950-0
 Fax +49 (0)7309.951-0
 info@peri.com
 www.peri.com